

Thanks for choosing Trumpchi manufactured by GAC Motor Co., Ltd. (hereinafter referred to as “GAC Motor”). For a better driving pleasure, please read the Owner’s Manual carefully. Through this manual, you can fully understand the operation methods and precautions of the vehicle. Proper operation of the vehicle can improve driving safety and prolong the service life of the vehicle.

The Warranty Manual supplied with the vehicle clearly describes the warranty services provided by GAC Motor and the regular maintenance of the vehicle. Please read this manual carefully to know your rights and responsibilities.

After reading this manual, please store it with the vehicle for future reference.

In case of any doubts about this manual, please contact the GAC Motor authorized shop for detailed explanation.

If you have any suggestions or recommendations, please contact GAC Motor through the customer service hotline: +86-400-158-9999.

We are grateful for your support and love for Trumpchi. Have a nice drive!

# Safety Instructions

---



The safety of you and the passengers is crucial, so driving safely is an important responsibility of the driver.

In order to make clear the safety precautions, we indicate the operation steps and precautions through various signs on the vehicle and this manual, reminding you to pay attention to the potential dangers that will hurt you or other occupants.

It is impossible to list all the precautions for danger related to operation and maintenance of the vehicle in the manual, so it is up to you to make the correct judgment in time.

Safety instructions are available in many forms, including:

- **Safety signs** - pasted on the vehicle.
- **Safety notes** - the texts marked with “**WARNING**”, “**CAUTION**”, or “**NOTE**” in front.

 <b>WARNING</b>
 <b>CAUTION</b>
 <b>NOTE</b>

Very important instructions of which the nonobservance can cause casualties.

Important instructions of which the nonobservance can cause damage to the vehicle.

General instructions of which the nonobservance could not cause injuries.

- Some paragraphs of this manual do not apply to all vehicle models. For the description of options, the title of them is followed by the symbol “\*\*”.
- Unless otherwise specified, the directions of the vehicle (front, rear, left and right) referred to in this manual are based on the traveling direction of the vehicle.



<b>1. Important safety precautions .....</b>	<b>1</b>	3.6 Safety label.....	34
<b>2. Picture index .....</b>	<b>3</b>	<b>4. Operation of systems and equipment .....</b>	<b>35</b>
2.1 Exterior .....	3	4.1 Cab .....	35
2.2 Interior .....	6	4.1.1 Steering wheel .....	35
<b>3. Instructions for safe operation .....</b>	<b>10</b>	4.1.2 Instrument cluster .....	37
3.1 Safe driving.....	10	4.1.3 Indicator lamp .....	43
3.1.1 General description.....	10	4.2 Vehicle locking and unlocking.....	47
3.1.2 Correct sitting posture of the driver and passengers .....	11	4.2.1 Remote control key.....	47
3.2 Seat belt .....	12	4.2.2 Emergency mechanical key.....	51
3.2.1 Why must you fasten the seat belt.....	12	4.2.3 Door lock system .....	52
3.2.2 Seat belt.....	14	4.2.4 Flush-fit door handle .....	57
3.3 SRS .....	17	4.2.5 Door .....	59
3.3.1 Cases where the airbags may deploy.....	22	4.2.6 Liftgate .....	59
3.3.2 Cases where the airbags might not deploy.....	23	4.2.7 Engine hood.....	64
3.4 Safe ride of children.....	24	4.2.8 Power windows .....	65
3.4.1 General description.....	24	4.2.9 Electric sunshade* .....	68
3.4.2 Child safety seat .....	25	4.2.10 Basic operation of body anti-theft system.....	70
3.4.3 Information about child safety seat .....	27	4.3 Lamps and vision .....	71
3.4.4 Correct installation of child safety seat ...	29	4.3.1 Exterior lamps .....	71
3.5 Exhaust gas hazard.....	33	4.3.2 Interior lamps .....	77
		4.3.3 Wiper combination switch.....	79
		4.3.4 Windshield .....	81

## Table of contents

---

4.3.5	Rearview mirror .....	82	4.6.6	Child seat with smart Bluetooth* .....	114
4.3.6	Sun visor.....	85	4.6.7	Settings.....	115
4.4	Seats and storage facilities.....	86	4.7	Emergency rescue .....	119
4.4.1	Headrest .....	86	<b>5. Driving guide.....</b>	<b>120</b>	
4.4.2	Front seat.....	87	5.1	Starting and driving.....	120
4.4.3	Rear seat .....	88	5.1.1	Engine start/stop button.....	120
4.4.4	Storage facilities .....	89	5.1.2	Engine start .....	121
4.4.5	Low battery reminder .....	92	5.1.3	Engine shutdown .....	122
4.4.6	Quiescent current management function	92	5.1.4	Gear description .....	123
4.4.7	Power outlet / USB interface.....	93	5.2	Brake system.....	126
4.4.8	Trunk .....	94	5.2.1	Service brake .....	126
4.4.9	Luggage rack.....	96	5.2.2	EPB.....	129
4.4.10	Accessories and modifications .....	96	5.3	Electronic service brake system .....	133
4.5	HVAC system.....	98	5.3.1	Electronic stability program (ESP) .....	133
4.5.1	General description.....	98	5.3.2	Anti-lock brake system (ABS) .....	135
4.5.2	A/C system .....	99	5.3.3	HHC .....	137
4.5.3	A/C air outlet.....	105	5.3.4	HDC* .....	137
4.6	AV system .....	106	5.3.5	HBC .....	138
4.6.1	Buttons on the right of the steering wheel*106		5.4	Driving assistance system .....	139
4.6.2	Basic operations .....	107	5.4.1	ACC* .....	139
4.6.3	Radio .....	111	5.4.2	Integrated cruise assist (ICA)* .....	149
4.6.4	Local music.....	112	5.4.3	Forward collision mitigation (FCM)* .....	155
4.6.5	Bluetooth function.....	113			

<ul style="list-style-type: none"> <li>5.4.4 Traffic sign recognition (TSR)* ..... 160</li> <li>5.4.5 Intelligent speed limiter adaptive cruise control (ISL-ACC)* ..... 162</li> <li>5.4.6 Lane departure warning (LDW)* ..... 163</li> <li>5.4.7 Intelligent headlamp control (IHC)* ..... 169</li> <li>5.4.8 Radar and IFC sensor* ..... 171</li> <li>5.4.9 Tire pressure monitoring system (TPMS) 174</li> <li>5.5 Parking assist systems ..... 176 <ul style="list-style-type: none"> <li>5.5.1 Rear parking assist (RPA) ..... 176</li> <li>5.5.2 Reverse image system* ..... 179</li> <li>5.5.3 Around view monitor (AVM)* ..... 181</li> </ul> </li> <li>5.6 Electric power steering (EPS)..... 187</li> <li>5.7 Driving skills ..... 188 <ul style="list-style-type: none"> <li>5.7.1 Pre-driving safety inspection ..... 188</li> <li>5.7.2 Driving during running-in period ..... 188</li> <li>5.7.3 Driving essentials ..... 190</li> <li>5.7.4 Efficient use of vehicle ..... 191</li> <li>5.7.5 Fire prevention ..... 192</li> </ul> </li> <li><b>6. Use and maintenance ..... 194</b> <ul style="list-style-type: none"> <li>6.1 Maintenance instructions ..... 194</li> <li>6.2 Interior maintenance ..... 194</li> <li>6.3 Exterior maintenance ..... 196</li> </ul> </li> </ul>	<ul style="list-style-type: none"> <li>6.4 Inspecting and adding oils ..... 200 <ul style="list-style-type: none"> <li>6.4.1 Fuel ..... 200</li> <li>6.4.2 Engine oil ..... 202</li> <li>6.4.3 Coolant ..... 205</li> <li>6.4.4 Windshield washer fluid and wiper blade 208</li> <li>6.4.5 Brake fluid ..... 210</li> <li>6.4.6 Battery ..... 212</li> </ul> </li> <li>6.5 A/C filter ..... 214</li> <li>6.6 Replacing bulb ..... 214</li> <li>6.7 Wheel ..... 214</li> <li>6.8 Tire chain ..... 219</li> <li><b>7. Technical data ..... 221</b> <ul style="list-style-type: none"> <li>7.1 Vehicle identification number (VIN) ..... 221</li> <li>7.2 Vehicle dimension parameters ..... 223</li> <li>7.3 Vehicle mass, engine and oil parameters ..... 224</li> <li>7.4 Transmission, chassis and lamp specifications 227</li> <li>7.5 Fuse specifications ..... 230</li> </ul> </li> <li><b>8. Accident handling ..... 236</b> <ul style="list-style-type: none"> <li>8.1 Driver's tools and spare tire ..... 236</li> <li>8.2 Use of warning triangle ..... 237</li> <li>8.3 Use of reflective vest ..... 238</li> </ul> </li> </ul>
---	--

## Table of contents

---

8.4 Replacement of flat tire.....	238
8.5 Fuse.....	242
8.6 Emergency start .....	244
8.7 Vehicle towing.....	246
8.8 Vehicle out of trap.....	248

# 1. Important safety precautions

## ◆ Be sure to wear the seat belt correctly

The seat belt is the best protection device in the event of a collision. Airbags are only designed as auxiliaries, rather than replacements, of the seat belts, so even if the vehicle is equipped with airbags, make sure that you and the passengers always fasten the seat belts correctly.

## ◆ Do not leave children in an unattended vehicle

Do not leave children in an unattended vehicle, as injury or even death may occur if they trigger a control device accidentally, or when the vehicle is moved accidentally and collided with other objects due to their mis-operation, and besides, the temperature inside the vehicle may reach an extreme condition, depending on the ambient temperature.

## ◆ Protect all children

Children aged 12 or under should be properly restrained in the 2nd-row seats rather than the front seats. Child safety seats shall be used for infants and toddlers; and child safety seats and three-point seat belts shall be used for older children, until it can be assured that the children can fasten the seat belts (without booster seats) properly

## ◆ Beware of danger of airbag

Airbags can save lives, but they can also cause serious or fatal injuries to occupants who are too close to the airbags or improperly restrained.

Airbags pose the greatest risk to infants, toddlers and short adults, so please follow all instructions and warnings in this manual.

## ◆ Never drink and drive

Drinking alcohol, even a little, will reduce your response capability, and your reaction time after drinking will become longer, so drinking and driving is strictly prohibited.

## ◆ During driving, please abide by the road traffic safety laws and yield to pedestrians.

## ◆ Be sure to pay attention to driving safety

Traffic accident will occur if you are busy answering the phone or handling other things so that you can not pay attention to road conditions, other traffics and pedestrians during driving. Please avoid distraction during driving.

## ◆ Control speed

Excessive speed is one of the main causes of traffic accidents. The faster the speed is, the greater the risk will be. Therefore, please choose the appropriate speed for safe driving according to the actual road conditions.

## ◆ Regular maintenance

Tire burst or mechanical failure is very dangerous. In order to reduce the possibility of such problems, please check the tire pressure and status frequently, and carry out regular maintenance as specified in the Warranty Manual

# 1. Important safety precautions

---

## Event data recorder (EDR)

This vehicle is equipped with an event data recorder (EDR). The EDR is mainly designed to record data in the event of certain collisions (such as airbag deployment or collision with a barrier), so as to help understand the operation of the vehicle system. EDR is specially used to record data related to vehicle dynamic control and safety systems in a short period of time. However, depending on the severity and type of collision, data may not be recorded.

The data specially recorded by the EDR of this vehicle include:

- The depressed status of the brake pedal (if applicable).
- Vehicle speed.
- Vehicle longitudinal acceleration.
- VIN.

These data help better understand the situation in the event of a collision and personal injury, and are used to assist accident analysis.

### **i** NOTE

The EDR will record data only when a certain degree of collision occurs to the vehicle; EDR will not record data during normal driving.

## EDR data disclosure

Except for the following circumstances, GAC Motor will not disclose the data recorded in the EDR to third parties:

- Reaching an agreement with the owner (or the lessee of the rental vehicle).
- At the official request of the police, courts or government agencies.

If necessary, the data will be used in:

- Research on vehicle safety performance.

## How to obtain EDR data reading tool

Special technical equipment is required to read EDR data. For more information, please contact GAC Motor authorized shop.

### 2.1 Exterior

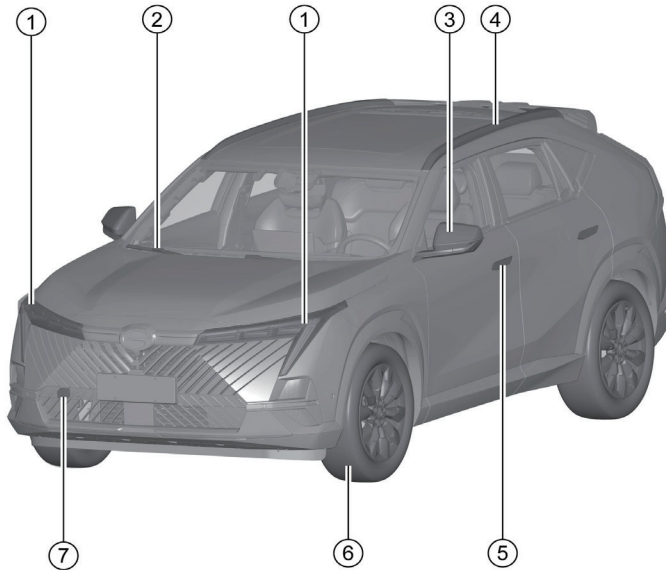

- ① Front combination lamp
  - Turning on lamps => [See page 71](#)
  - Replace bulbs => [See page 214](#)
  - Front combination lamp bulb specifications => [See page 229](#)
- ② Front wiper
  - Replace the front windshield wiper blade => [See page 209](#)
- ③ Exterior rearview mirror
  - Side turn signal lamp => [See page 72](#)
  - Side turn signal lamp specifications => [See page 229](#)
- ④ Luggage rack => [See page 96](#)
- ⑤ Door lock hole => [See page 53](#)
- ⑥ Wheel => [See page 214](#)
- ⑦ Front towing => [See page 247](#)

## 2. Picture index

---

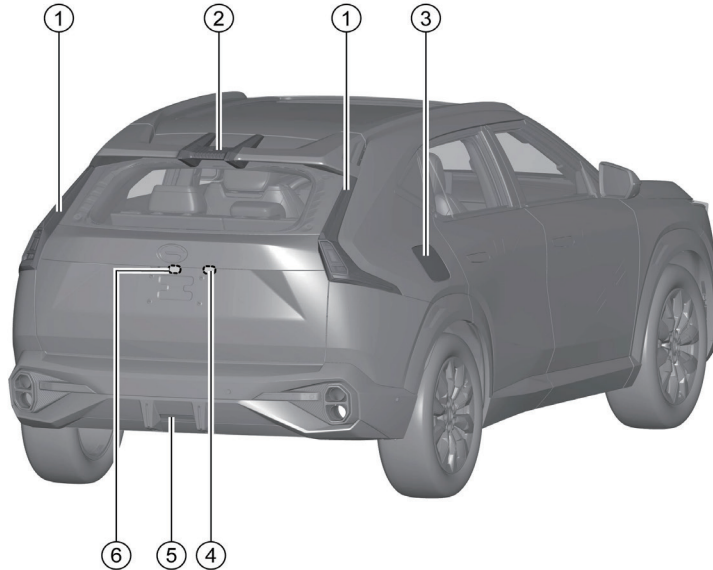

- ① Rear combination lamp
  - Rear combination lamp bulb specifications => See page 229
- ② High-mounted stop lamp
  - High-mounted stop lamp specifications => See page 229
- ③ Fuel tank cover => See page 200
- ④ Liftgate unlocking button => See page 60
- ⑤ Rear fog lamp and reverse lamp
  - Rear fog lamp specifications => See page 229
  - Reverse lamp specifications => See page 229
- ⑥ License plate lamp
  - License plate light specifications => See page 229



## 2. Picture index

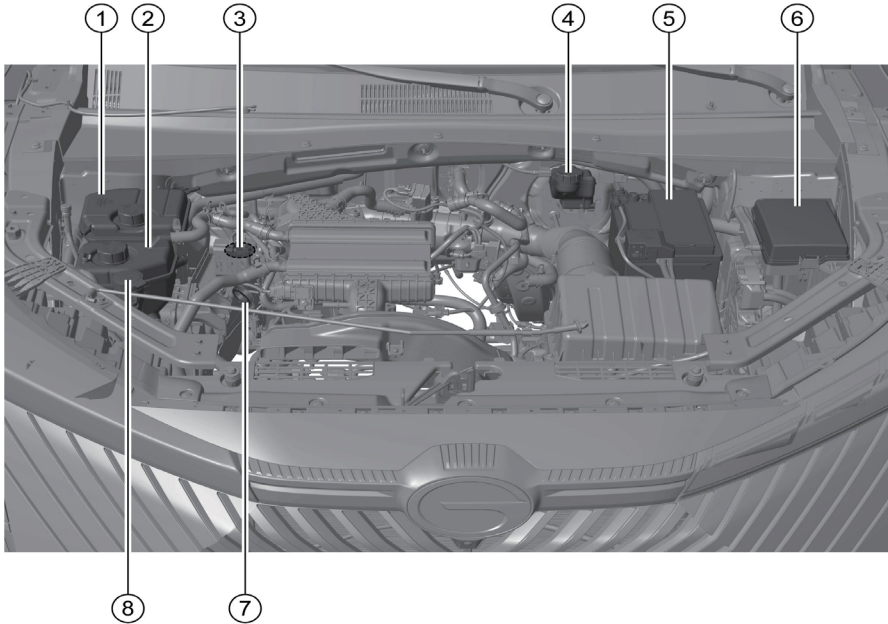

- ① Engine coolant reservoir => See page 206
- ② Intercooler coolant expansion tank => See page 206
- ③ Oil filler cap => See page 204
- ④ Brake fluid reservoir => See page 211
- ⑤ Battery => See page 212
- ⑥ Engine compartment power distribution unit => See page 242
- ⑦ Oil dipstick => See page 203
- ⑧ Windshield washer fluid reservoir => See page 208

## 2. Picture index

### 2.2 Interior

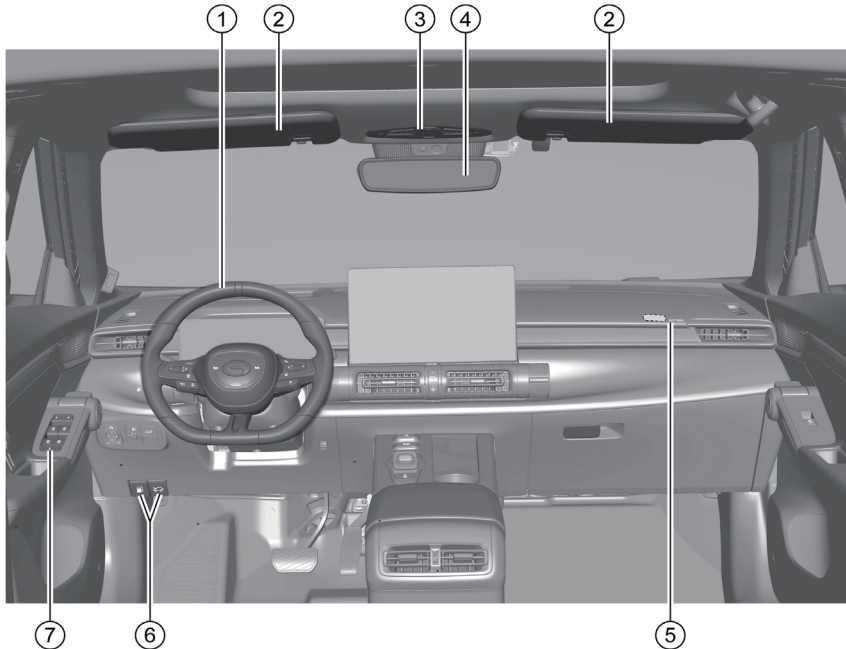

- ① Steering wheel => See page 35
  - Steering wheel button => See page 36
  - Driver's frontal airbag => See page 18
- ② Sun visor => See page 85
- ③ Front dome lamp => See page 77
  - Electric sunshade button \* => See page 68
  - SOS button \* => See page 119
- ④ Interior rearview mirror => See page 82
- ⑤ Front passenger's frontal airbag => See page 19
- ⑥ Engine hood release handle => See page 64
  - Fuel tank cap unlocking button => See page 200
- ⑦ Driver's power window control button => See page 65
  - Central locking button => See page 52

## 2. Picture index

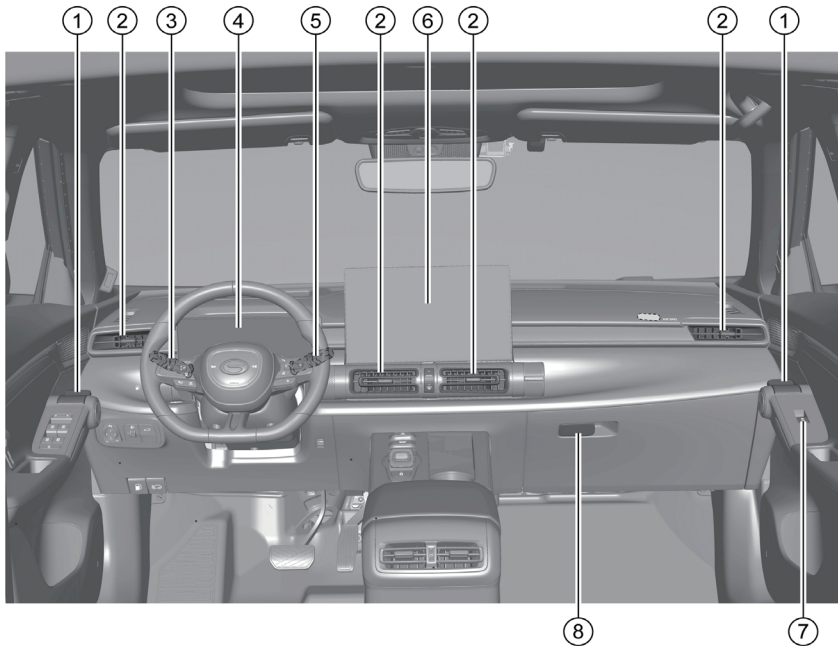

- ① Inside handle => See page 52
- ② A/C air outlet => See page 105
- ③ Light combination switch => See page 71
- ④ Instrument cluster => See page 37
- Indicator lamp => See page 43
- ⑤ Wiper combination switch => See page 79
- ⑥ A/V system => See page 107
- ⑦ Passenger's power window control button => See page 66
- ⑧ Glove box opening handle => See page 91

## 2. Picture index

---

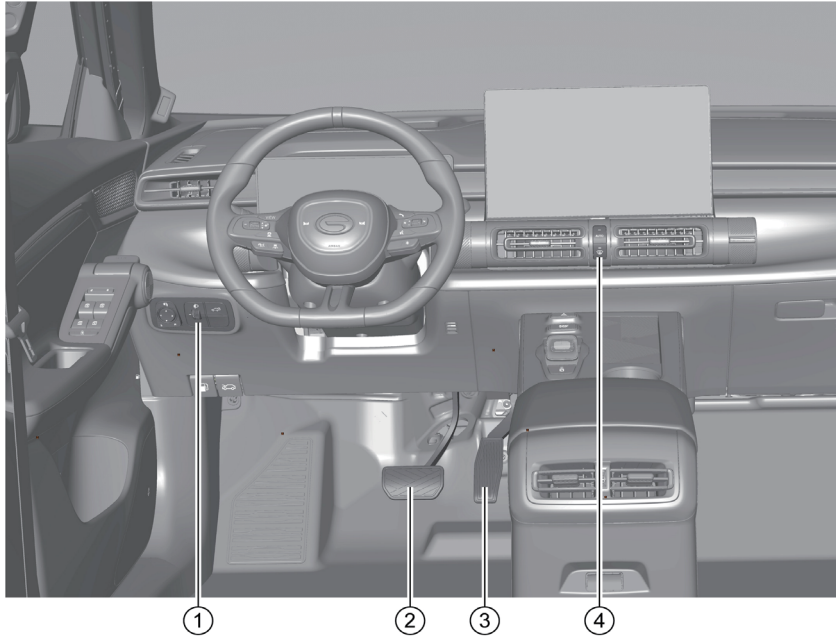

- ① Instrument panel left switch block
  - Exterior rearview mirror folding button \*  
=> See page 84
  - Exterior rearview mirror adjusting button  
=> See page 83
  - ALS knob => See page 75
  - Liftgate button => See page 60
- ② Brake pedal
- ③ Accelerator pedal
- ④ A/C control button => See page 101

## 2. Picture index

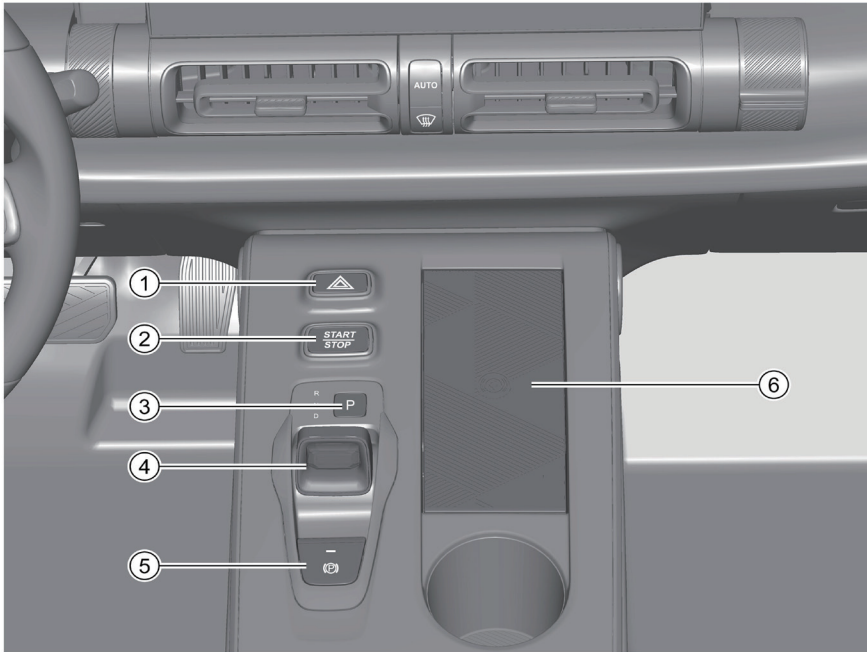

- ① Hazard warning lamp switch button => See page 76
- ② ENGINE START/STOP button => See page 120
- ③ "P" position button => See page 123
- ④ Gearshift lever => See page 123
- ⑤ EPB button => See page 129

## 3. Instructions for safe operation

### 3.1 Safe driving

#### 3.1.1 General description

This section introduces important information, operating essentials, recommendations and safety precautions for safe driving. For the safety of you and the passengers, please read carefully and follow the relevant regulations.

#### NOTE

Please always keep the *Owner's Manual* in the vehicle. If you lend or resell the vehicle to someone else, be sure to hand the complete set of accompanying documents over to the new owner.

The following inspections must be carried out before driving:

- Check that all lamps are working properly.
- Check that the fuel level is normal.
- Check that the coolant level is normal.
- Check that the brake fluid level is normal.
- Confirm that the oil level is normal.
- Check that the windshield washer fluid level is normal.
- Check that the tire pressure is normal.
- Check that the engine hood is closed and locked properly.
- Check that all windows are clear and have a good view.
- Check that no objects obstruct the movement of the driver's foot pedals.
- Adjust the seat, head restraint and rearview mirror according to your body height and shape.
- Use appropriate child safety seats to protect children and help them fasten the seat belts correctly.
- Fasten the seat belt correctly and remind all passengers in the vehicle to fasten the seat belts correctly.



#### WARNING

**When installing the driver's floor mat, please observe the following precautions:**

- Do not overlap two or more floor mats.
- Do not make the bottom surface of the floor mat upward or back-to-front.
- Do not use floor mats that are incompatible with this model.



#### CAUTION

- Do not distract yourself from external factors during driving.
- Do not drive the vehicle when your response capability reduces, such as due to medicines, alcohol, or drugs.
- Strictly abide by traffic regulations.

### 3.1.2 Correct sitting posture of the driver and passengers

#### Correct sitting posture of the driver

The driver's sitting posture directly affects his/her fatigue level and driving safety. Before driving, the driver should:

- Sit up straight and adjust the seat back to a suitable position so that your back fits completely the seat back.
- Adjust the seat position so that all pedals can be operated effectively with slightly bent legs.
- Correctly adjust the seat headrest. => See page 86
- Wear the seat belt correctly. => See page 15
- Adjust the steering wheel position. => See page 35

#### WARNING

**Do not adjust the seat, headrest or steering wheel during driving; otherwise the vehicle may be out of control, leading to an accident.**

#### Correct sitting posture of the passengers

To guarantee the safety of the passengers and reduce the risk of casualties, the passengers should:

- Sit up straight and adjust the seat headrest correctly. => See page 86
- Adjust the distance between the seat and the instrument panel as demanded (for front passenger).
- Adjust the seat back to a suitable position so that the back fits completely the seat back (for front passenger).
- Wear the seat belt correctly. => See page 15
- The passenger should place both feet on the floor.
- Use appropriate child safety seat in accordance with applicable regulations for children. => See page 25

#### WARNING

- It is forbidden to install a child safety seat in the front passenger's seat.
- If the front passenger is too close to the instrument panel, the SRS will not provide effective protection.
- When the vehicle is running, be sure to maintain a correct sitting posture and fasten the seat belt correctly, so as to avoid unexpected injuries in case of emergency braking or accidents.

### 3. Instructions for safe operation

#### 3.2 Seat belt

##### 3.2.1 Why must you fasten the seat belt

Protection of the driver and passengers by seat belts



In the event of a vehicle collision, the seat belt, if fastened correctly, can restrain the driver and passengers in a proper position and slow down the inertia of their forward movement, thus preventing them from being thrown forward, and at the same time allow airbags to give them the best protection, thus reducing their impact injury as much as possible.

In a car collision, the seat belts assist other safety systems in simultaneously absorbing the energy generated by the collision, further reducing the injuries suffered by the driver and passengers.

#### WARNING

**Airbags cannot replace seat belts. Regardless of whether the car is equipped with airbags, the seat belts should be worn correctly.**

#### Consequences of not fastening the seat belt

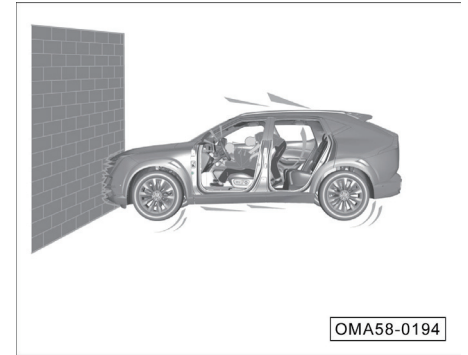

In the event of a collision, the driver or passenger who does not fasten the seat belt will be thrown forward due to inertia and thereby injured.



### 3. Instructions for safe operation

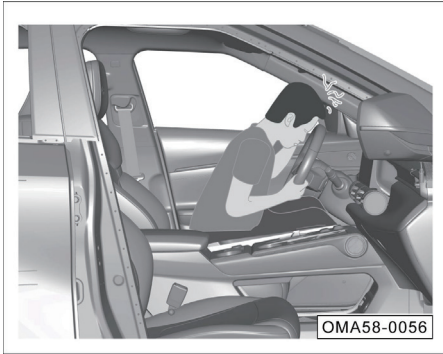

Even if the vehicle speed is very low, the force acting on the human body in the event of a collision is so great that the occupant cannot control his or her body with hands at all. In that case, the occupant who does not fasten the seat belt will be thrown forward, and injured if colliding with any interior objects.

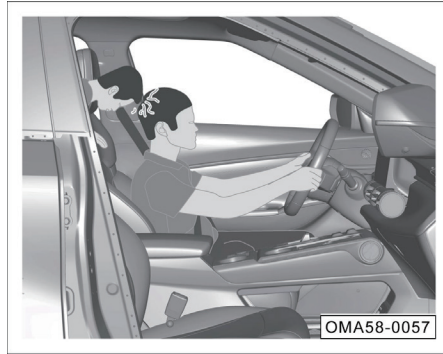

Rear passengers must also fasten the seat belts correctly, otherwise they will be thrown forward when an accident occurs. The passenger who does not fasten the seat belt will not only hurt himself or herself, but also endanger other occupants in the vehicle.

### 3. Instructions for safe operation

#### 3.2.2 Seat belt

##### Seat belt indicator lamp

 : Driver's seat belt indicator lamp

 : Front passenger's seat belt indicator lamp

When the ignition switch is set to "ON" position, the alarm message appears as follows:

- when the vehicle speed is lower than 20 km/h, if the driver or front passenger does not fasten the seat belt, the corresponding indicator lamp in the instrument cluster will flash for about 6 s and stay on.
- when the vehicle speed is higher than or equal to 20km/h, if the driver or front passenger does not fasten the seat belt, the corresponding indicator lamp in the instrument cluster will flash for a period of time and stay on, accompanied by an alarm message and a continuous audible alarm.

#### CAUTION

- Before driving, please check whether there are any heavy objects on the front passenger's seat to avoid the system mistakenly determining that the seat is occupied and issuing a false alarm.
- If the alarm remains on after the seat belt is fastened correctly, it means that the seat belt reminder fails. In that case, please contact the GAC Motor authorized shop for inspection in time.

#### WARNING

**Never insert the substitute of seat belt tongue into the buckle to eliminate the seat belt alarm.**

 : Rear seat belt indicator lamp\*

If rear seat belt indicator lamp is on in white, it indicates that the seat belt is fastened, and if the indicator lamp is on in red, it indicates that the seat belt is not fastened or the seat belt system is faulty. If the indicator lamp stays red after the seat belt is fastened correctly, it means that the SRS is failed. In that case, please go to the GAC Motor authorized shop for inspection in time.

The rear seat belt indicator lamp is on for a period of time and then goes out, and it will light up under the following conditions:

- The rear passenger does not fasten the seat belt when the engine starts.
- The rear passenger does not fasten the seat belt when the rear door is opened/closed.
- The rear passenger fastens or unfastens the seat belt.

### 3. Instructions for safe operation

#### Seat belt pretensioner and load limiter\*

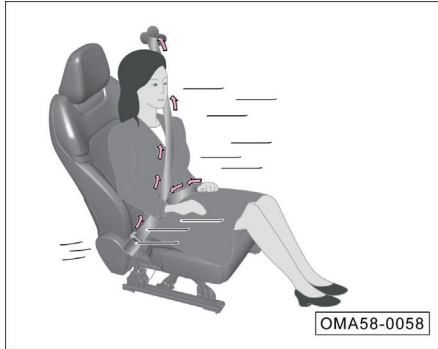

The seat belt pretensioner and load limiter can reduce the pressure of the seat belt on the chest of the driver or passenger and improve the protection performance.

- Before the collision, the seat belt pretensioner and load limiter can restrain the driver or passenger and enable him or her to maintain a correct sitting posture to prevent the body from leaning forward.
- In the event of a severe collision where the triggering condition is reached, the seat belt pretensioner and load limiter will be triggered, driving the seat belt webbing to be quickly retracted and tensioned.

- When a vehicle collision occurs, the human body will move forward, and the seat belt load limiter will be activated at this time, so that the restraint force of the seat belt on the human body will be within a certain range, preventing the occupant from being further injured due to excessive force. And at the same time, the seat belt pretensioner and load limiter will work with the airbag to achieve a better safety protection performance.

#### i NOTE

- When the seat belt pretensioner and load limiter is activated, a little harmless smoke together with a sound will be produced, which is normal.
- The seat belt pretensioner and load limiter cannot be used any more if deployed, and in this case, the SRS indicator lamp  stays on, please contact the GAC Motor authorized shop for replacement.

#### Fastening the front seat belt

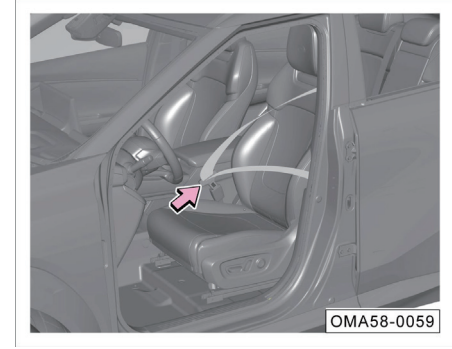

- Keep a correct sitting posture. => See [page 11](#)
- Pull out the seat belt slowly at a uniform speed, and insert the tongue into the corresponding buckle until a click is heard.
- Pull the seat belt and confirm that the tongue is properly locked.

#### i NOTE

Rear seat belts are fastened in the same way, and the driver is responsible for reminding passengers to fasten the seat belts correctly.

### 3. Instructions for safe operation

#### Unfastening the seat belt

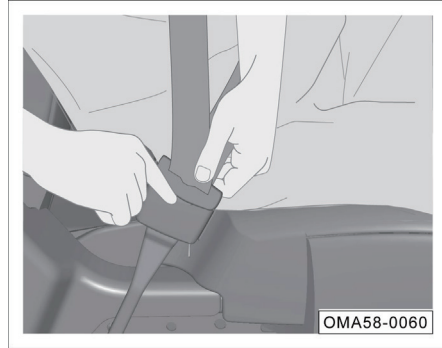

- Press the red button of the buckle. Then the lock tongue will pop out automatically.
- Hold the seat belt to allow it to retract slowly.

#### Pregnant women must fasten the seat belts correctly



How does a pregnant woman correctly fasten the seat belt?

- Position the seat and headrest properly.
- Grasp the lock tongue, slowly pull the seat belt over the shoulder, and ensure that the lap belt is as low as possible and not pressed against the abdomen.
- Insert the tongue into the corresponding buckle until a click sound is heard.
- Pull the shoulder belt upward parallel to the upper body, tension the lap belt, and make sure that the lock tongue is properly locked.

#### WARNING

To reduce the risk of injury during emergency braking or accidents, please observe the following precautions:

- Before driving, make sure that all occupants have properly fastened the seat belts.
- Each seat belt is for one person only. Do not share a seat belt with other persons (including children).
- Do not recline the front seat back excessively for comfort.
- Do not put the shoulder belt under or behind your arm.
- Be sure to insert the lock tongue into the buckle of corresponding side instead of the buckle of other side.
- Never unfasten the seat belt before the vehicle comes to a complete stop.

#### 3.3 SRS

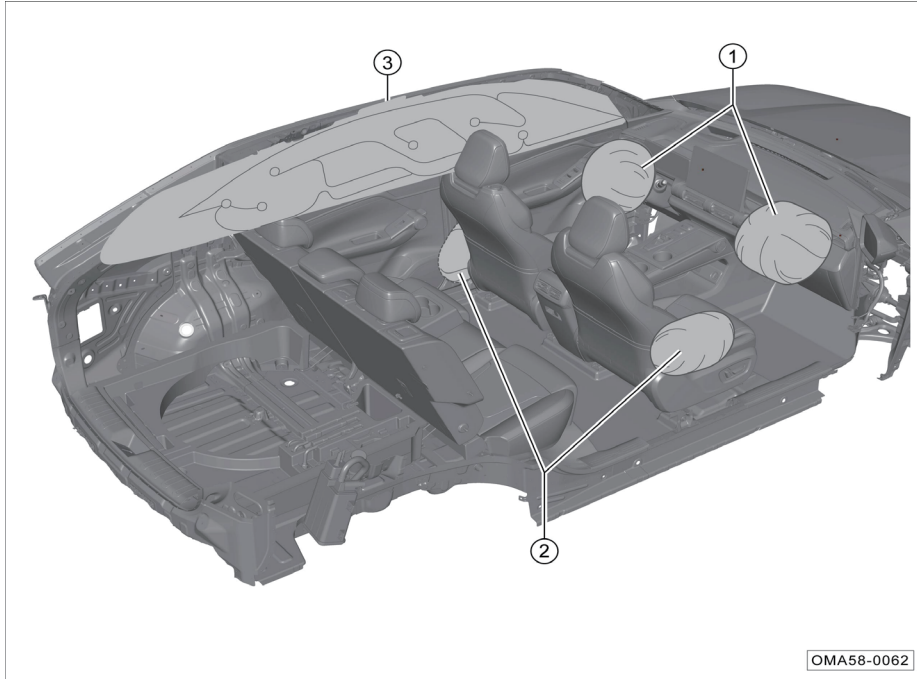

Depending on vehicle configurations, the deployment positions of the SRS are as shown below:

- ① Front seat frontal airbags.
- ② Front seat side airbags \*
- ③ Side curtain airbags (bilaterally symmetrical) \*

#### **i** NOTE

The airbag will produce a little harmless smoke when deployed, which is normal.

### 3. Instructions for safe operation

#### Supplemental restraint system (SRS) indicator lamp

With the vehicle power switch set to “ON” position, the indicator lamp  will be on for a few seconds and go out after the system completes self-test.

 A system fault is indicated when the indicator lamp is in the following conditions:

1. The indicator lamp does not come on after the vehicle power switch is set to “ON” position.
2. With the vehicle power switch set to “ON” position, the indicator lamp does not go out after the system completes self-test.
3. After the vehicle power switch is set to “ON” position, the indicator lamp goes out but then comes on again.
4. The indicator lamp comes on or flashes while the vehicle is running.

#### WARNING

- **Never attempt to repair, adjust or modify the airbag.**
- **The airbag can be deployed once only, and thus, if it is deployed in an accident, please contact the GAC Motor authorized shop for replacement.**
- **When the SRS is faulty, please contact the GAC Motor authorized shop for inspection and repair. Otherwise, the system cannot trigger or abnormally triggers the airbag in the event of a vehicle collision.**

#### Front airbags

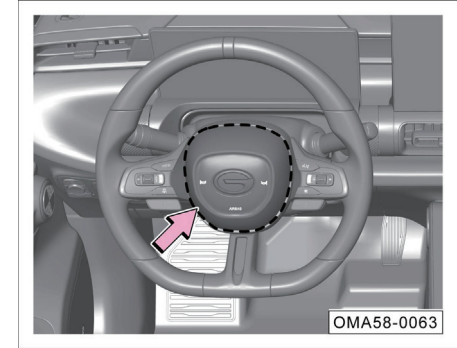

The driver's frontal airbag is installed inside the steering wheel (as indicated by the dotted dash) marked with “AIRBAG”.

### 3. Instructions for safe operation

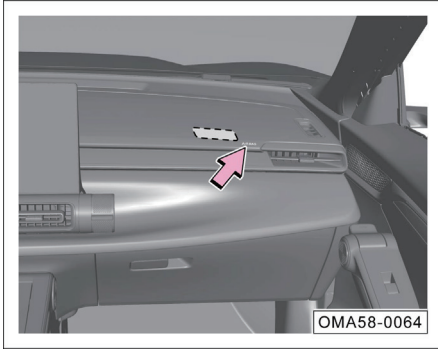

The front passenger's frontal airbag is installed inside the instrument panel (as indicated by the dotted dash) marked with "AIRBAG".

In the event of a frontal collision which is severe enough to meet the triggering condition of frontal airbag, the frontal airbags will be triggered by the system and deploy rapidly to assist the seat belt in protecting the driver and front passenger.

In certain collision accidents, the system may simultaneously trigger other airbags.

#### **WARNING**

**Do not attach or place any decorative objects on the surface of instrument panel, because when the vehicle is running or the airbag deploys, these objects will fall, be knocked over and roll around in the vehicle, affecting the driver and hurting the passengers in the vehicle.**

The front seat frontal airbags might not be triggered in the following cases:

- The vehicle power switch set to "ACC" or "OFF" position.
- Minor frontal collision.
- Side collision.
- Rear-end collision.
- Rollover.
- Other special circumstances.

#### **NOTE**

The word "minor" implies the severity of collision sensed by the SRS controller and has nothing to do with the damage of the vehicle.

### 3. Instructions for safe operation

#### Front seat side airbag\*



The front seat side airbags are installed in the outboard sides of the driver's seat back and the front passenger's seat back respectively (as indicated by the dotted dash) marked with "AIRBAG".

In the event of a side collision which is severe enough to meet the triggering condition of frontal airbag, the side airbags will be triggered by the system and deploy rapidly to assist the seat belt in protecting the driver and front passenger.

In certain collision accidents, the system may simultaneously trigger other airbags.

The front seat side airbags might not be triggered under any one of the following:

- The vehicle power switch set to "ACC" or "OFF" position.
- 100% frontal collision.
- Minor side collision.
- Rear-end collision.
- Other special circumstances.

#### i NOTE

The word "minor" implies the severity of collision sensed by the SRS controller and has nothing to do with the damage of the vehicle.

#### ⚠ WARNING

- Airbag warning label is provided on pillar B on both sides of the vehicle. Please follow the warning on the label. Do not lean your body against the door side equipped with side airbags during driving.
- Do not cover the side airbags with seat covers or other objects; otherwise, the side airbags will not be deployed to protect the occupants when an accident occurs.



#### Side curtain airbag\*

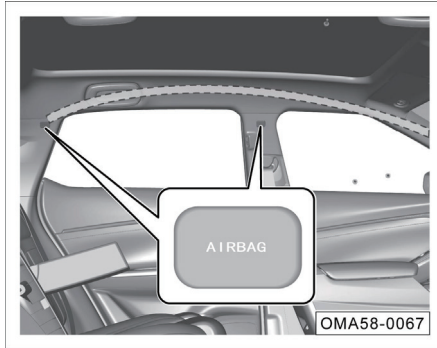

Side curtain airbags are installed in the left and right sides of the roof respectively (as indicated by the dotted dash) marked with "AIRBAG".

In the event of a side collision which is severe enough to meet the triggering condition of side curtain airbag, the curtain airbag on the side where the collision occurs will be triggered by the system and deploy rapidly to assist the seat belt in protecting the driver and front passenger.

In certain collision accidents, the system may simultaneously trigger other airbags.

The side curtain airbags might not be triggered in the following cases:

- The vehicle power switch set to "ACC" or "OFF" position.
- 100% frontal collision.
- Minor side collision.
- Rear-end collision.
- Other special circumstances.

#### **i** NOTE

The word "minor" implies the severity of collision sensed by the SRS controller and has nothing to do with the damage of the vehicle.

### 3. Instructions for safe operation

#### 3.3.1 Cases where the airbags may deploy

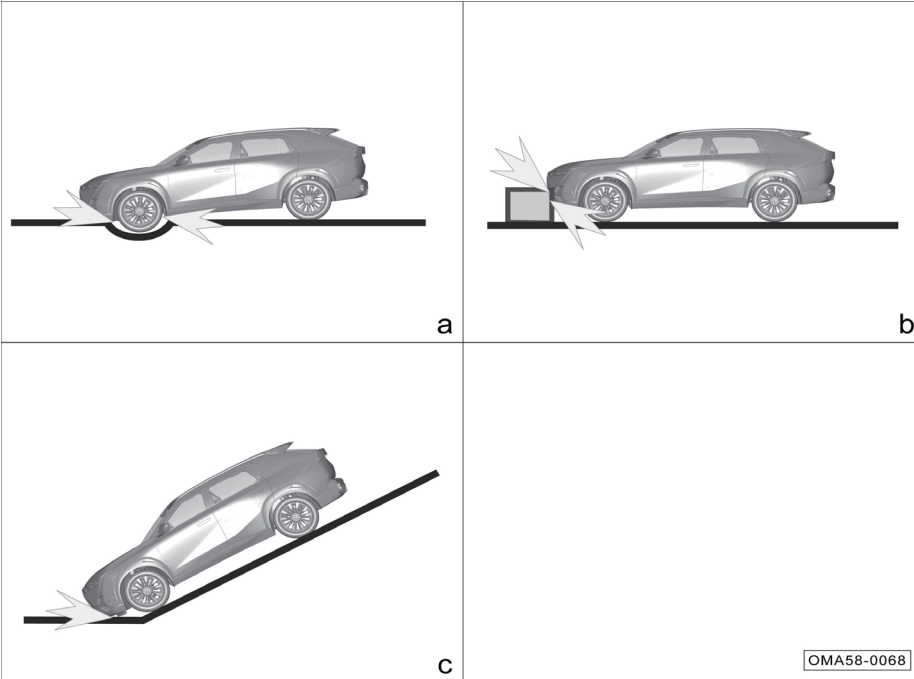

- a. Hitting of nose to the ground after crossing a deep groove.
- b. Collision with roadside protrusions, curbs, etc.
- c. Hitting of nose to the ground after running down a steep slope.

OMA58-0068

### 3. Instructions for safe operation

#### 3.3.2 Cases where the airbags might not deploy

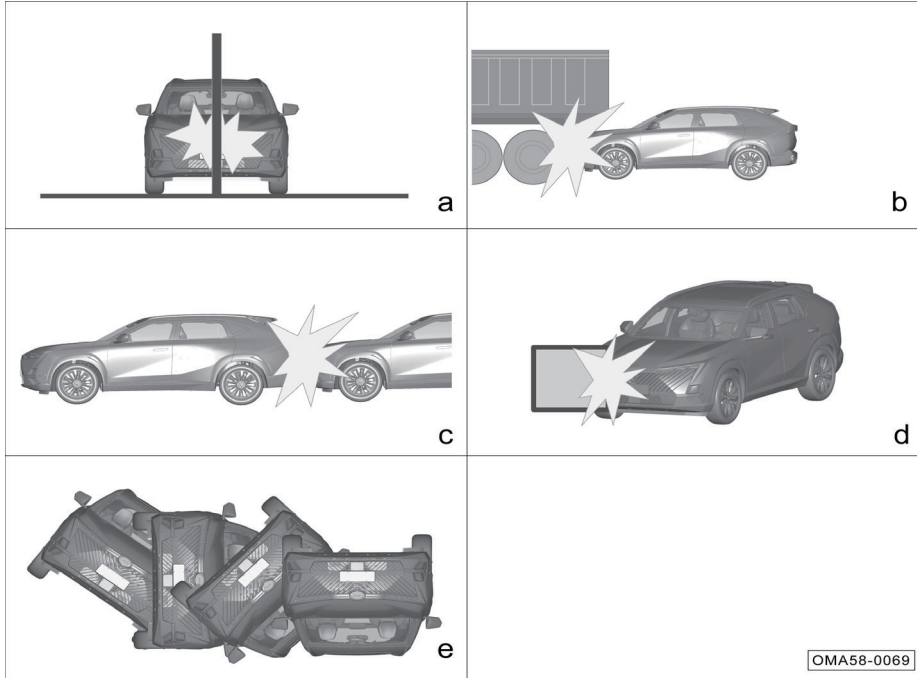

- a. Collision with concrete pillars, trees or other elongated objects.
- b. Rear-end collision with the lower rear end of large truck.
- c. Rear-end collision by other vehicles.
- d. Offset frontal collision with a wall or another vehicle
- e. Rollover.

OMA58-0069

## 3. Instructions for safe operation

### 3.4 Safe ride of children

#### 3.4.1 General description

The child must sit in a rear seat (2nd row), and a suitable child safety seat should be selected for protection according to the body size of the child.



Warning labels are pasted on the front and back of the right sun visor to remind the front passenger of the danger of frontal airbag. Be sure to read and follow the instructions on the labels.

#### ⚠ WARNING

- Do not install any rear-facing child restraint system on seats with frontal airbags!
- Even if the child has been put in a child safety seat, do not let the head or any part of the body rest on the door area (the deployment area of the front seat side airbag\* or side curtain airbag\*); otherwise the impact force of the deployed front seat side airbag\* or side curtain airbag\* can cause serious injury or even death of the child.
- Do not let children stand or kneel on the seat.
- Do not allow children to operate devices that may cause pinch to themselves (such as power window, power sunshade, etc.).

#### ⚠ WARNING

- Never leave children alone in the vehicle!
- Never hold infants or toddlers on your knees!
- Seat belts are not suitable for infants and toddlers as they can cause injuries in the event of an accident.
- Ensure that in the event of a collision or emergency braking, children are less likely to be injured by hitting any hard objects in the vehicle.
- Lock the child safety lock of the door on the side where the child sits. => See page 54

### 3. Instructions for safe operation

#### 3.4.2 Child safety seat



a. Group 0/0+ child safety seat



b. Group I child safety seat



c. Group II child safety seat



d. Group III child safety seat

OMA58-0070

**Classification of child safety seats (for reference only):**

- a. **Group 0/0 + child safety seat:**
  - Suitable for infants weighing less than 13kg.
- b. **Group I child safety seat:**
  - Suitable for toddlers weighing between 9kg and 18kg. For children weighing up to 18 kg (3 years old), rear-facing child safety seats must be installed.
- c. **Group II child safety seat:**
  - Suitable for children weighing between 15kg and 25kg.
- d. **Group III child safety seat:**
  - Suitable for children weighing between 22kg and 36kg.

### 3. Instructions for safe operation

---

Group I child safety seat Welldon Angela 2nd Generation, product model: WD002-ZJC.

Precautions for installation:

- Adjustment of seat body: Rear-facing seat is recommended. Adjust the seat body to make it upright. (almost vertical) state.
- Adjustment of headrest: It is recommended that the headrest be flush with the shoulder of the child.
- It is recommended that the pull hook of the upper strap be fixed to the interface of the rear top cross member of the vehicle.
- It is recommended the top tether be along both sides of the child seat headrest.
- It is recommended that clip gasket and shoulder belt jacket be used.

#### **i** NOTE

During the actual installation of the child safety seat, be sure to refer to the instruction of the child safety seat for correct installation.

### 3.4.3 Information about child safety seat

Information about the applicability of different seating positions for child restraint systems:

Mass group	Mounting position		
	Front passenger's seat	Outboard 2nd-row seats	2nd-row center seat
Group 0: <10kg	X	U	X
Group 0+: <13kg	X	U/UF	X
Group I: 9~18 kg	X	U/UF/L	X
Group II: 15~25 kg	X	UF	X
Group III: 22~36 kg	X	UF	X

Note: The uppercase letters in the table are defined as follows:

**U=** The “general” child restraint systems approved for this weight group are suitable.

**UF=** The forward-facing “general” child restraint systems approved for this weight group are suitable.

**L=** The listed special child restraint systems are suitable, which may be for special vehicles, or of restricted or semi-general categories.

**X=** Not suitable for child restraint system of this mass group.

For some child safety seats, a size class is specified. Be sure to check the size class according to the manufacturer’s instructions, packaging, and child safety seat label. For guidance on proper installation, please refer to the instruction of the child safety seat.

### 3. Instructions for safe operation

#### ISOFIX mounting positions for ISOFIX child safety seats

Mass group	Size class	Fixture module	Mounting position		
			Front passenger's seat	Outboard 2nd-row seats	2nd-row center seat
Carry-cot	F	ISO/L1	X	X	X
Group 0: <10kg	G	ISO/L2	X	X	X
	E	ISO/R1	X	IUF/IL	X
Group 0+: <13kg	E	ISO/R1	X	IUF/IL	X
	D	ISO/R2	X	IUF/IL	X
	C	ISO/R3	X	IUF/IL	X
Group I: 9~18 kg	D	ISO/R2	X	IUF/IL	X
	C	ISO/R3	X	IUF/IL	X
	B	ISO/F2	X	IUF/IL	X
	B1	ISO/F2X	X	IUF/IL	X
	A	ISO/F3	X	IUF/IL	X
Group II: 15~25 kg	-	-	X	IUF	X
Group III: 22~36 kg	-	-	X	IUF	X

Note: The uppercase letters in the table are defined as follows:

**IUF** - The “forward-facing” general ISOFIX child safety seats for this weight group that are fixed with top tether are suitable.

**IL** - The listed special ISOFIX child restraint systems are suitable, which may be for special vehicles, or of restricted or semi-general categories.

**X** - The child safety seats for this weight group are not suitable.

For some child safety seats, a size class is specified. Be sure to check the size class according to the manufacturer's instructions, packaging, and child safety seat label. For guidance on proper installation, please refer to the instruction of the child safety seat.



## 3. Instructions for safe operation

### 3.4.4 Correct installation of child safety seat

The child safety seat is generally installed by three-point seat belt, ISOFIX system, or LATCH system.

To ensure a better protection effect and prevent the headrest from affecting the performance of the child safety seat during use, it is recommended to remove the headrest of the seat on which the child safety seat is installed.

#### **i** NOTE

During the actual installation of the child safety seat, be sure to refer to the instruction of the child safety seat for correct installation.

### Installation of child safety seat by three-point seat belt



1. Place the child safety seat on the rear seat (2nd row).
2. Pass the seat belt through the child safety seat and fully insert the tongue into the buckle until a click sound is heard.

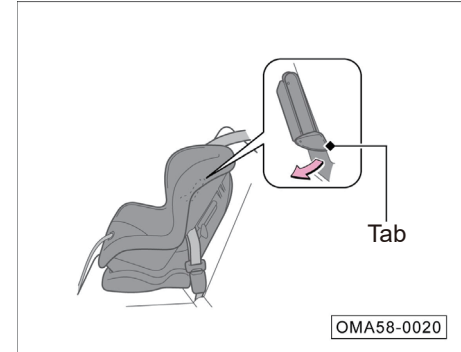

3. Push the tongue down and pass the shoulder belt through the slit on the side of the child safety seat.

### 3. Instructions for safe operation

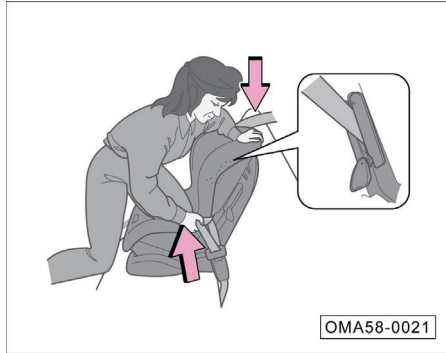

4. Grasp the shoulder belt near the buckle and pull it up to tension the lap belt. At this time, press the child safety seat with your own weight and push it into the vehicle seat.

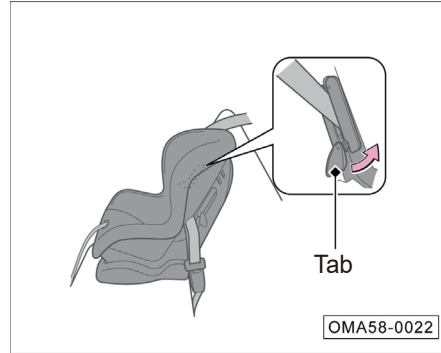

5. Place the seat belt correctly and push the tab up. Make sure the seat belt is not twisted. When pushing the tab up, pull upward the upper part of the shoulder belt to tension the belt.

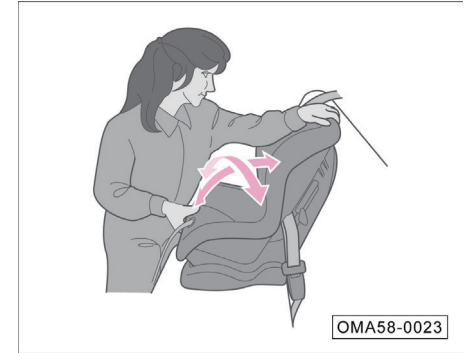

6. Shake the child safety seat back and forth, left and right to make sure it is firmly fixed.
7. Make sure that all unused seat belts in the reach of the children are locked.

### 3. Instructions for safe operation

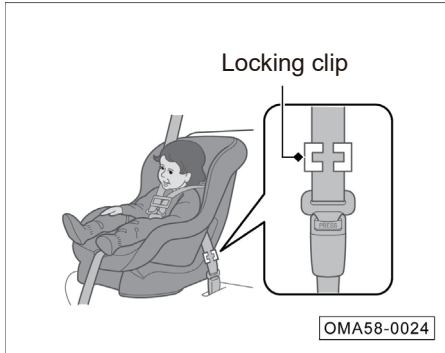

If no means are provided on the child safety seat for securing the seat belt, please install a locking clip on the seat belt.

- After the above steps 1 and 2, pull up the shoulder belt and make sure the lap belt is tensioned.
- Firmly grasp the seat belt near the tongue. Pinch the two parts of the seat belt together so that they do not slip out of the tongue. Unbuckle the seat belt.

Install the locking clip as shown. Place the clip as close as possible to the tongue and insert the tongue into the buckle. Proceed to steps 6 and 7.

#### Installing ISOFIX system

The rear seats (2nd-row) of this vehicle are equipped with the ISOFIX system, and thus suitable for the ISOFIX child safety seats.

#### ⚠ WARNING

- **The child safety seat anchorages installed in this vehicle can be used to fix the child safety seats only.**
- **Do not connect straps, hard and sharp objects or any other objects other than child safety seats to the anchorages; otherwise children may be endangered in the event of an accident.**

#### Rear seat

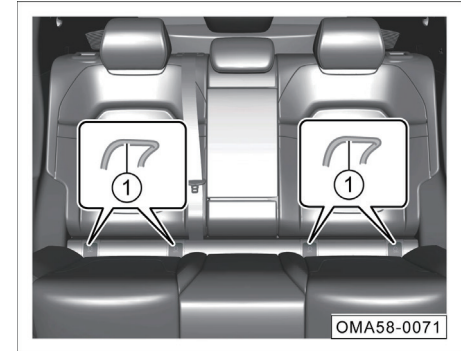

Open the cover, then you can see the front anchorage ① on the 2nd-row seat.

### 3. Instructions for safe operation

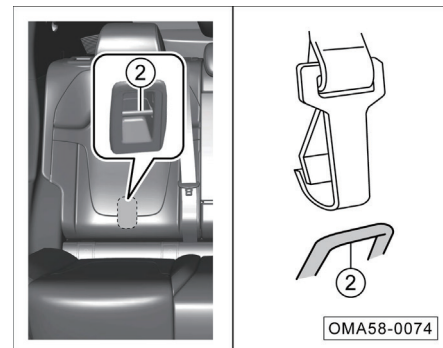
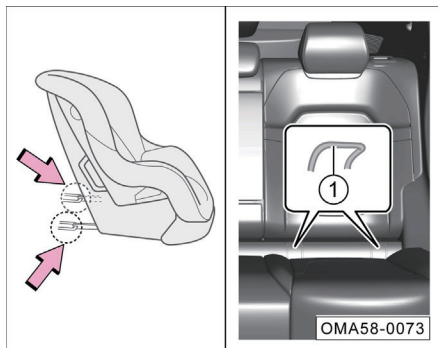
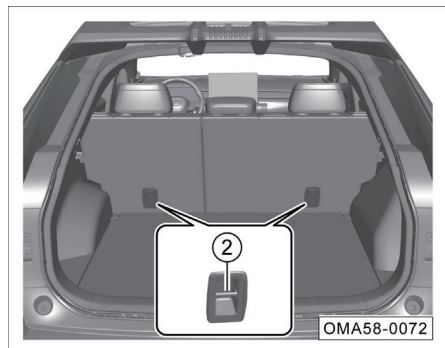

#### **i** NOTE

The rear anchorage ② of the rear seat is located behind the backrest or in the ceiling above the rear seat. The rear anchorage behind the backrest is taken as an example, and can be seen after opening the protective cap.

1. Put the child safety seat on the seat, open the cover and find the front anchorage ①. Then insert the lower guide groove of the child safety seat as arrowed into the front anchorage ① until a click is heard.
2. Thread the strap through the top of seat back, open the protective cover of rear anchorage ②, and attach the strap hook to the rear anchorage ② with the strap not twisted.
3. Tension the strap and shake the child safety seat to ensure it is firmly fixed.

### 3.5 Exhaust gas hazard

#### Carbon monoxide gas

The exhaust gas emitted by the engine contains the toxic carbon monoxide gas. Please use the vehicle correctly to prevent the carbon monoxide gas from entering the vehicle.

Please contact the GAC Motor authorized shop to check whether the exhaust system is normal in the following cases:

- The exhaust system makes abnormal noises.
- The exhaust color is abnormal.

If the engine is idling during parking, please open all the windows and turn on the HVAC system:

1. Select the fresh air mode.
2. Select  mode.
3. Set the fan speed to the maximum.



#### WARNING

- **Carbon monoxide gas is toxic, and inhaling a great quantity of it will cause loss of consciousness and even death.**
- **When the engine is started for a long time in a confined space (such as a garage, etc.), carbon monoxide will quickly accumulate, resulting in excessive carbon monoxide in the vehicle. After starting the engine, drive the vehicle away from the confined space immediately.**

### 3. Instructions for safe operation

#### 3.6 Safety label

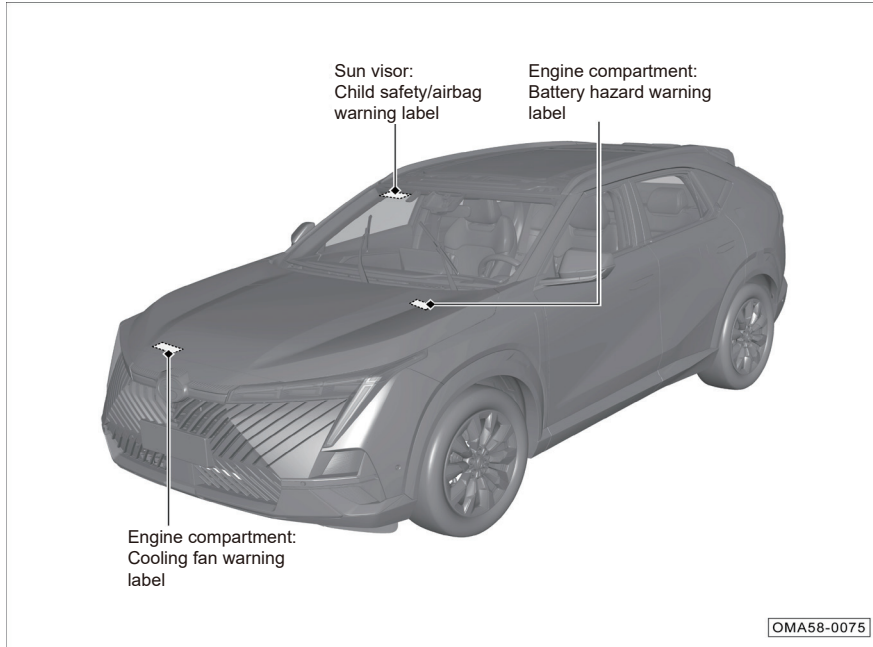

The labels are located as shown to remind you of the potential danger that can cause serious injury or death. Please read these labels carefully.

If the label comes off or is difficult to read, please go to the GAC Motor authorized shop in time for replacement.

#### **i** NOTE

In case of any discrepancy in the illustrated location or quantity of the labels, the actual vehicle shall prevail.

## 4. Operation of systems and equipment

### 4.1 Cab

#### 4.1.1 Steering wheel

Adjust the steering wheel position



- Adjust the driver's seat to a suitable position, so that the distance between the steering wheel and your chest is not less than 25 cm.

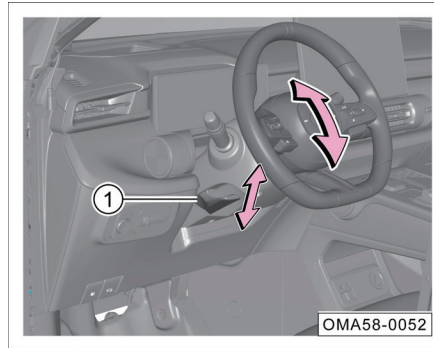

- Push down the locking handle ① to unlock the steering wheel.
- Adjust the steering wheel to the appropriate position up, down, front, and back as required, so that you can see the instrument panel and all indicator lamps.
- Pull up the locking handle ① to lock the steering wheel and make sure it is firmly locked.

#### CAUTION

If a great locking force is applied for locking the locking handle, you can release the locking handle again and then shake it up and down for locking again.

#### WARNING

- During driving, the driver's hands should always grasp the outer ring of the steering wheel (9 o'clock and 3 o'clock positions).
- After adjustment, the steering wheel must be locked to prevent shifting while the vehicle is running.
- Only when the vehicle is stopped can the steering wheel be adjusted to avoid traffic accidents.
- To ensure safety, the steering wheel should face your chest, otherwise the airbag cannot provide effective protection in the event of an accident.

## 4. Operation of systems and equipment

### Steering wheel button

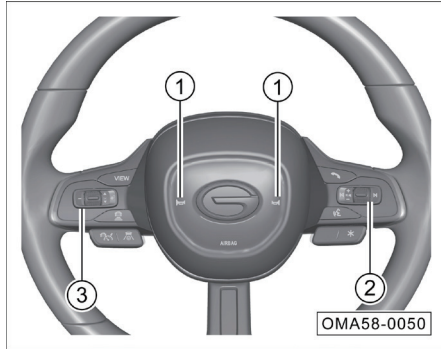

- ① Horn button: Press button to sound the horn;  release the button to stop sounding the horn.

#### WARNING

Do not press and hold  button for a long time; otherwise the horn is highly prone to be damaged.

- ② Control buttons of AV system => See page 106
- ③ Steering wheel button:
- Control buttons of the instrument cluster display\*:
    - Instrument panel theme switching \* => See page 39
    - Driving information operation => See page 39
    - Alarm information operation => See page 41
  - Cruise control button \*:
    - ACC button => See page 139
    - TJA/ICA control button => See page 150



## 4. Operation of systems and equipment

### 4.1.2 Instrument cluster

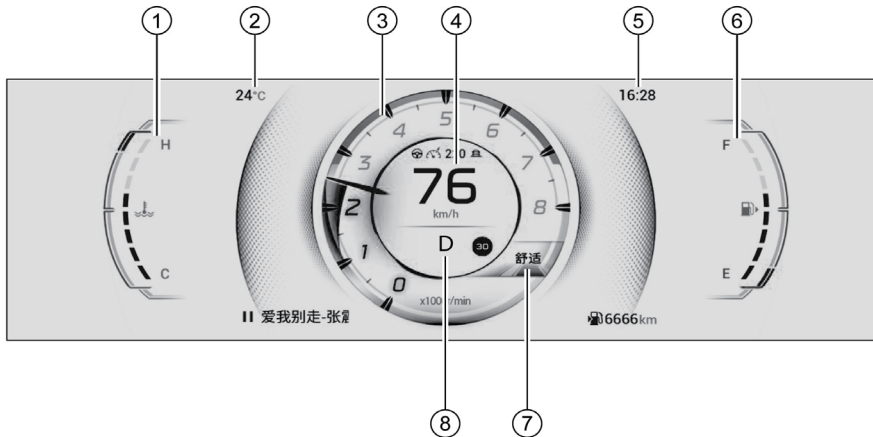

#### Instrument cluster with 7-inch display \* (organic theme)

- ① Engine coolant temperature gauge
- ② Outside temperature display
- ③ Tachometer
- ④ Speedometer
- ⑤ Time display
- ⑥ Fuel gauge
- ⑦ Driving mode
- ⑧ Gear display

#### **i** NOTE

The instrument cluster with 7-inch display allows for multiple themes, including "Global theme" and "Organic theme". The organic theme is illustrated here and for reference only. Please refer to the actual vehicle.

OMA58-0215

## 4. Operation of systems and equipment

### Tachometer

The tachometer is used to indicate the current engine speed, in 1,000r/min.

#### CAUTION

The area of 6000~8000 r/min represents the high load area of the vehicle. Avoid running the vehicle with the pointer of the tachometer within this area; otherwise, fuel shut-off and loss of power will occur due to self-protection of the engine.

### Speedometer

The speedometer indicates the current speed of the vehicle in km/h, in the range of 0~240 km/h.

#### WARNING

**For driving safety, please strictly abide by the traffic rules, and never speed the vehicle.**

### Engine coolant temperature gauge

The engine coolant temperature gauge is used to indicate the current temperature of the engine coolant.

- The indication range covers C~H, where, “C” means low temperature and “H” means high temperature.

After the engine is started, the corresponding scale divisions of the coolant temperature gauge will be illuminated according to different temperatures, and the engine operating temperature will vary depending on the ambient temperature and engine load.

- Conditions where the gauge indicates high coolant temperature: prolonged climbing in hot weather; deceleration or stop after driving at a high speed; in areas with heavy traffic, where the HVAC system is turned on and the engine idles for a long time; towing, etc.
- Conditions where the gauge indicates low coolant temperature: insufficient warm-up after cold start in cold weather; running with maximum heating in cold weather, etc.

### Fuel gauge

The fuel gauge is used to indicate the current amount of fuel remaining in the fuel tank.

- The indication range is E~F, where “E” means the fuel tank is empty, and “F” means the fuel tank is full. The corresponding scale divisions are illuminated according to the remaining fuel in the fuel tank.
- When no scale division is illuminated or only the first scale division is illuminated, it means that the fuel in the fuel tank is insufficient. In that case, the yellow indicator lamp  on the instrument cluster will flash, accompanied by the the top pop-up text to remind the driver to refuel in time.

### Gear display information

- The current gear information of the vehicle such as “P”, “R”, “N” or “D” is displayed according to the received signal.

### Driving mode information

- The current driving mode of the vehicle is displayed according to the received signal.

## 4. Operation of systems and equipment

### Outside temperature display

- The current outside temperature is displayed on the screen.

### Odometer

- The odometer indicates the traveled distance of the vehicle in the driving information screen.
- The indication range is 0~999999 km.

### Instrument cluster display

The displayed information includes: driving information, vehicle state, fuel consumption trend, ADAS, alarm center, navigation information, call information, AV and entertainment information.

#### CAUTION

If the instrument cluster display is abnormal, stop the vehicle immediately for the sake of safety, and contact the GAC Motor authorized shop for inspection and repair.

### Instrument theme switching

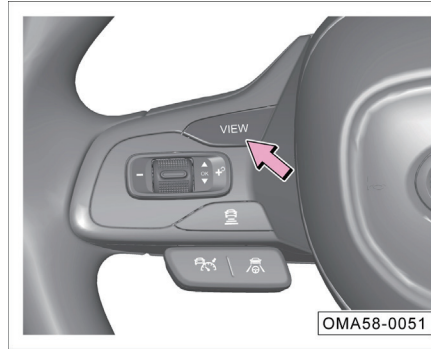

With vehicle power switch set to “ON[1]{2}” position, press “VIEW” button on the left of steering wheel to access the screen of theme setting of instrument panel.

### Driving information

When the vehicle power switch is set to “ON” position, move up or down the “OK” button on the left of the steering wheel to switch to display information screen.

- On the driving information screen, the current trip information, cumulative driving information and total distance are displayed.

### Current trip

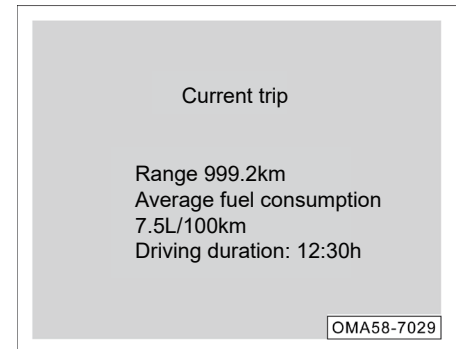

- Current trip: It indicates the driving information (trip distance/ average fuel consumption/ driving time) of the vehicle in a single drive after the ENGINE START/ STOP button is set to “ON” position. It will be reset after a single ignition cycle.

## 4. Operation of systems and equipment

### Cumulative distance

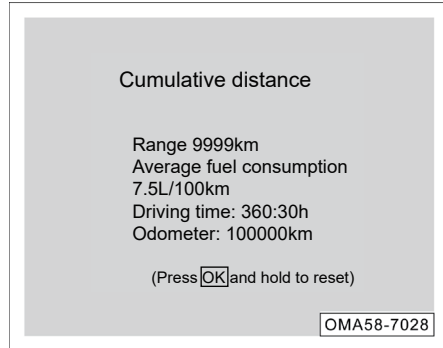

Cumulative driving: It indicates the driving information (cumulative distance/ average fuel consumption/ driving time) of the vehicle since the last reset. It can be reset by pressing and holding “OK” button on the left side of the steering wheel.

The total mileage information is displayed on this screen. It cannot be reset.

### Vehicle status

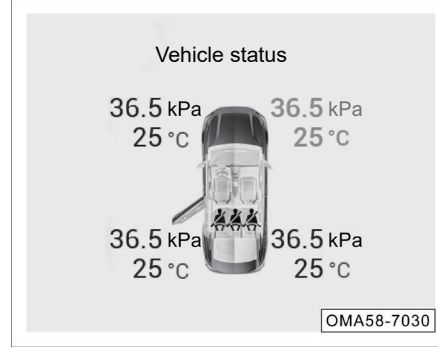

When the vehicle power switch is set to “ON” position, move up or down the “OK” button on the left of the steering wheel to view the vehicle state.

- The displayed information includes tire pressure, temperature, door state, and seat belt alarm message.
- This interface pops up automatically when the tire pressure or tire temperature is abnormal, and the door/liftgate/ engine hood is opened or seat belt is not fastened.

### AVDC mode \*

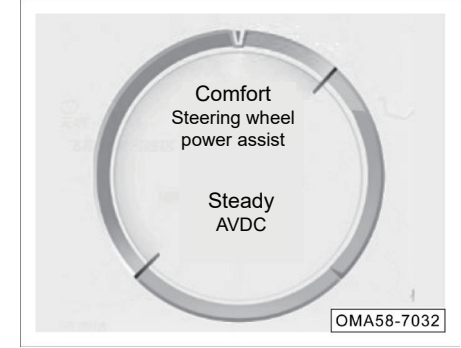

When the vehicle power switch is set to “ON” position, move up or down the “OK” button on the left of the steering wheel to view the shadow mode.

- The current steering wheel assist mode: sport/standard/comfort.
- The AVDC reflects the current state of the AVDC assist function.

## 4. Operation of systems and equipment

Fuel consumption trend \*

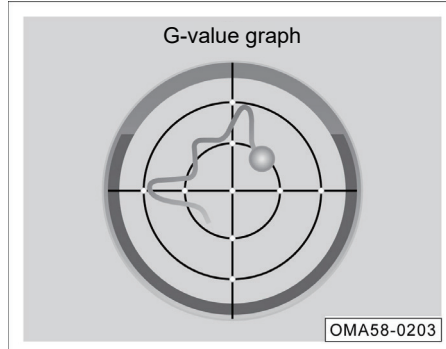

When the vehicle power switch is set to "ON" position, move up or down the "OK" button on the left of the steering wheel to view the fuel consumption trend.

- Display the fuel consumption trend and historical best fuel consumption of the last 50 km.

ADAS\*

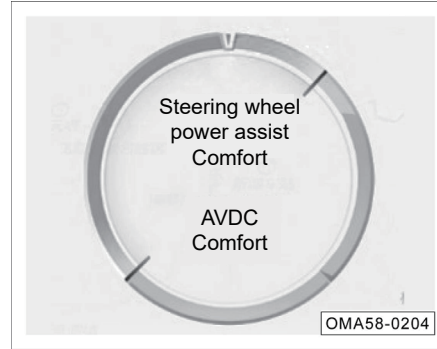

When the vehicle power switch is set to "ON" position, move up or down the "OK" button on the left of the steering wheel to view the information.

- The screen shows the current aided driving mode.

Alarm center

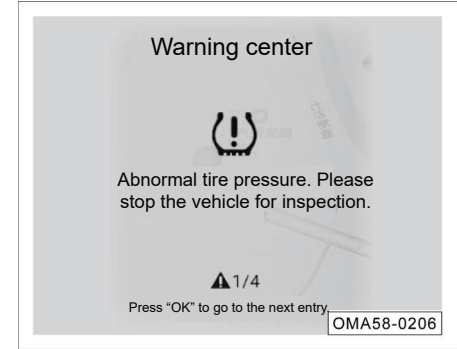

On the alarm center screen, the current state of the vehicle is displayed in the form of texts or pictures. The driver should always pay attention to checking for alarm message.

- If the vehicle is in normal condition, no alarm message is displayed.
- If the vehicle is faulty or certain function is activated/deactivated, corresponding text or picture message will appear at the upper part of the screen of the instrument cluster, reminding the driver about the current state of the vehicle.

## 4. Operation of systems and equipment

---

- If any alarm message appears, press “OK” button on the left of the steering wheel to confirm the message. Then the message will be displayed on the alarm center screen.
- In case of several alarm messages, corresponding number and current text message will be displayed on the alarm center screen.

### Call information

- When the AV system is connected to the Bluetooth of the mobile phone and there is an incoming call, the call information will be displayed at the lower of the instrument cluster display.
- When E-CALL\* is used, E-CALL\* state will be displayed on the call information screen.

### AV and entertainment information









- When the AV system is turned on, the current playback information will be displayed on the instrument cluster.

### Instrument cluster setting











With the vehicle power switch set to “ON” position, when the vehicle speed is zero, perform following function setting via “Settings→Display Setting→Instrument Panel” in the AV system:

## 4. Operation of systems and equipment

### 4.1.3 Indicator lamp











S/N	Icon	Name	Color	Function
1		Charging system warning lamp	Red	This warning lamp will come on when the engine is not started with the vehicle power switch set to "ON" position; This warning lamp will go out after the engine is started.
2		MIL	Yellow	If this warning lamp comes on after the engine is started, it indicates that the charging system is faulty. If this indicator lamp comes on after the engine is started, it indicates that the engine system is faulty.
3		Low oil pressure warning lamp	Red	This warning lamp will come on when the engine is not started with the vehicle power switch set to "ON" position; This warning lamp will go out after the engine is started.
4		Emission fault indicator lamp	Yellow	If this warning lamp comes on after the engine is started, it indicates that the engine oil pressure is low. If this indicator lamp comes on after the engine is started, it indicates that the exhaust system is faulty.
5		Left turn signal and hazard warning indicator lamp	Green	When the left turn signal indicator lamp flashes alone, it indicates that the left turn signal lamp of the vehicle is on. When the hazard warning lamp switch is pressed, the left/right turn signal indicator lamps and all turn signal lamps will flash simultaneously.
6		High coolant temperature indicator lamp	Red	If the red indicator lamp comes on, it indicates that the engine coolant temperature is too high.
7		Supplemental restraint system (SRS) indicator lamp	Red	If the red indicator lamp comes on, it indicates that the SRS system is faulty.
8		Low fuel level indicator lamp	Yellow	If the yellow indicator lamp flashes, it indicates that the fuel level of the fuel tank is low. If the yellow indicator lamp comes on, it indicates that the fuel pump may be faulty.

## 4. Operation of systems and equipment







S/N	Icon	Name	Color	Function
9		Right turn signal and hazard warning indicator lamp	Green	If the right turn signal indicator lamp flashes alone, it indicates that the right turn signal lamp of the vehicle is on. When the hazard warning lamp switch is pressed, the left/right turn signal indicator lamps and all turn signal lamps will flash simultaneously.
10		EPB status indicator lamp	Red	If the red indicator lamp flashes, it indicates that the EPB is engaged partially or faulty.
			Green	If the green indicator lamp comes on, it indicates that the EPB is activated.
11		EPB fault indicator lamp	Yellow	If the yellow indicator lamp comes on, it indicates that the EPB is faulty.
				If the yellow indicator lamp flashes, it indicates that the EPB is in the service mode.
12		Parking brake and brake system indicator lamp	Red	If the red indicator lamp comes on, it indicates that the brake fluid level is too low or the electronic brake force distribution (EBD) system is faulty.
13		ESP indicator lamp	Yellow	If the yellow indicator lamp comes on, it indicates that the ESP is faulty.
				If the yellow indicator lamp flashes, it indicates that the ESP is working.
14		ESP OFF indicator lamp	Yellow	If the yellow indicator lamp comes on, it indicates that the ESP is off.
15		ABS indicator lamp	Yellow	If the yellow indicator lamp comes on, it indicates that the ABS is faulty.
16		Transmission fault indicator lamp	Yellow	If the yellow indicator lamp comes on, it indicates that the transmission system is faulty.
				If the yellow indicator lamp flashes, it indicates that the transmission fluid temperature is high.
17		TPMS indicator lamp	Yellow	If the yellow indicator lamp comes on, it indicates that the TPMS is faulty.
18		Electric power steering (EPS) indicator lamp	Red	If the red indicator lamp comes on, it indicates that the EPS system is faulty.
19		Intelligent high beam indicator lamp *	White	If the white indicator lamp comes on, it indicates that the intelligent high beam is in standby state.
			Blue	If the blue indicator lamp comes on, it indicates that the intelligent high beam is activated.



## 4. Operation of systems and equipment

S/N	Icon	Name	Color	Function
20		ACC indicator lamp (no vehicle ahead)*	Grey	If the gray indicator lamp comes on, it indicates that the ACC system is in the ready state, and there is no target vehicle ahead.
			Blue	If the blue indicator lamp comes on, it indicates that the ACC system is working, and there is no target vehicle ahead.
21		ACC indicator lamp (a vehicle ahead)*	Grey	If the gray indicator lamp comes on, it indicates that the ACC system is in the suppression or ready state, and there is a target vehicle ahead.
			Blue	If the blue indicator lamp comes on, it indicates that the ACC system is working, and there is a target vehicle ahead.
22		ACC fault indicator lamp *	Yellow	If the yellow indicator lamp comes on, it indicates that the ACC system is faulty.
23		LDW status indicator lamp*	White	If the white indicator lamp comes on, it indicates that the LDW system is activated.
			Yellow	If the yellow indicator lamp comes on, it indicates that the LDW system is faulty. In that case, please go to the GAC Motor authorized shop for inspection in time.
			Blue	If the blue indicator lamp comes on, it indicates that the LDW system is working normally or intervenes with the steering wheel for deviation correction.
24		FCW status indicator lamp *	Yellow	If the yellow indicator lamp comes on, it indicates that the FCWS is faulty. In that case, please go to the GAC Motor authorized shop for inspection in time.
			Red	If the red indicator lamp flashes, it indicates that the FCWS is being triggered and activated.
25		Front passenger seat belt indicator lamp	Red	If the red indicator lamp comes on, it indicates that the front passenger's seat belt is not fastened or the system is faulty.
26		Driver's seat belt indicator lamp	Red	If the red indicator lamp comes on, it indicates that the driver's seat belt is not fastened or the seat belt system is faulty.
27		High beam indicator lamp	Blue	If the blue indicator lamp comes on, it indicates that the high beam is on.
28		Position lamp indicator lamp	Green	If the green indicator lamp comes on, it indicates that the position lamp, instrument panel lamp, license plate lamp, etc. are on.
29		Rear fog lamp indicator lamp	Yellow	If the yellow indicator lamp comes on, it indicates that the rear fog lamp is on.

## 4. Operation of systems and equipment

S/N	Icon	Name	Color	Function
30		Hill descent control (HDC) indicator lamp *	Yellow	If the yellow indicator lamp comes, it indicates that the HDC system is activated.
31		Hands off warning lamp*	Blue	If the blue indicator lamp comes on, it indicates that hands on steering wheel is detected by ICA.
			Red	If the red indicator lamp comes on, it indicates that hands off steering wheel is detected by ICA.
32		LKA status indicator lamp*	Grey	If the gray indicator lamp comes on, it indicates that ICA is in standby state.
			Blue	If the blue indicator lamp comes on, it indicates that ICA is activated.
			Yellow	If the yellow indicator lamp comes on, it indicates that ICA is faulty.
33		Rear seat belt indicator lamp *	White	If the white indicator lamp comes on, it indicates that the corresponding rear seat belt is fastened.
			Red	If the red indicator lamp comes on, it indicates that the corresponding rear seat belt is not fastened or the seat belt system is faulty.
34		Door opening indicator lamp	Red	If the red indicator lamp comes on, it indicates that the engine hood, any door or trunk lid has not been closed.
35		GPF indicator lamp	White	If the white indicator lamp comes on, it indicates that the accumulated carbon of the GPF exceeds a certain limit, and it is necessary to run at a high speed for more than 40 minutes to clean the carbon.
			Yellow	If the yellow indicator lamp comes on, it indicates that the accumulated carbon of the GPF is excessive, and it is necessary to run at a high speed for more than 40 minutes to clean the carbon.

Note: If any indicator or warning lamp on the instrument cluster comes on after the vehicle is started or during driving, it indicates that the related system or function is in a certain working state or faulty. You should read carefully and understand the meaning of each indicator lamp and warning lamp. In case of failure, please go to or contact the GAC Motor authorized shop in time to repair the vehicle.

### 4.2 Vehicle locking and unlocking

#### 4.2.1 Remote control key

This vehicle is accompanied with two intelligent remote control keys (including emergency mechanical key) and the corresponding key barcodes. If you need to re-customize the key, please inform the GAC Motor authorized shop of the key barcode. If the key barcode is missing, please inform the GAC Motor authorized shop of the VIN.

#### CAUTION

After the engine is started, do not place the remote control key on the instrument panel under the front windshield. Otherwise the prompt "Key not detected" may appear.

#### Weak signal of remote control key

The operation of the remote control key button may be interfered or unstable in the following cases:

- Nearby equipment is emitting strong radio waves.

- The remote control key is carried together with telecommunication equipment, laptop, mobile phone, access control card or wireless signal transmitter.
- The remote control key is put together with magnetic cards (such as bank card and bus card).
- Metal objects contact or cover the remote control key.

#### CAUTION

The remote control key contains an electronic circuit that can trigger the engine immobilizer system. If the circuit is damaged, the engine may not be started. Therefore,

- Avoid placing the remote control key in direct sunlight or in a high-temperature or humid place.
- Avoid dropping the remote control key from a high place or crushing it by heavy objects.
- Avoid exposing the remote control key to any liquid. If the key gets wet accidentally, dry it immediately.

#### NOTE

- The buttons of the remote control key do not work when the ENGINE START/STOP button is set to "ACC" or "ON" position.
- If the unlocking or locking function of the remote control key is deactivated, you can try to press the buttons on the remote control key 3 times continuously to activate the function.

## 4. Operation of systems and equipment

### Button operations

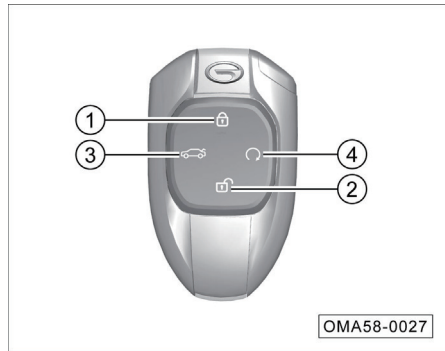

- ① : Locking button
- ② : Unlocking button
- ③ : Liftgate unlocking button
- ④ : Engine start/stop button

### ① Button operations

- Press the button once within the effective range, so that all doors will be locked; if this button is pressed and held, the doors windows and sunshade will be closed automatically. If the button is released when the windows or the sunshade\* is being closed automatically, the windows or the sunshade\* will stop moving.
- If this button is pressed continuously for 2 times within 0.5 s, the vehicle locating function will be realized and the turn signal lamps will flash 3 times quickly.

### CAUTION

Before closing the windows by the remote control key, make sure that there are no body parts (such as head and hands) in the movement path of the windows so as to prevent a risk of pinch injury.

### NOTE

- When the door is locked, the turn signal lamp flashes once; the horn will sound once; the horn sounding can be turned on or off by "Settings → Sound Effect Settings → System Sound Effect → Unlock/Lock Prompt Sound" in the AV system.
- The locking-sensitive window closing can be turned on or off by AV system "Settings → body accessories → door/window lock → locking-sensitive window closing". After the function is turned on, press the button once within the effective range, so that all doors will be locked and the windows will be closed automatically.

## 4. Operation of systems and equipment

### ② Button operations

- Press and hold the button for a short time once within the valid range to unlock all doors; press and hold the button to open the windows of the four doors; during the opening of the windows, release the button to stop.

### CAUTION

If the door is not opened within 30 s after being unlocked by pressing the unlocking button  on the remote control key, the system will lock the door again.



### NOTE

- When the doors are unlocked, the turn signal lamps will flash twice, and the horn will sound twice. The horn sounding can be turned on or off by “Settings → Sound Effect Settings → System Sound Effect → Unlock/Lock Prompt Sound” in the AV system.
- All the four doors or the driver’s door can be unlocked by pressing the button  after setting via “Settings → Body accessories → Door/window lock → Remote unlocking”.

### ③ Button operations



- If the vehicle has the PLG function, two presses on the button within the effective range can open the liftgate electrically. During the opening process, if the button is pressed again, the liftgate will stop at the current position.
- If the vehicle does not have the PLG function, two presses on the button within the effective range will unlock the liftgate with the need of manual opening of the liftgate.

### ④ Button operations

- Within the effective range, if the button  is pressed and then the button  is pressed and held within 5 s, the turn signal lamps will flash and the engine can be remotely started.
- When the engine has been started remotely, press and hold the button  for about 3 s to shut down the engine remotely.

## 4. Operation of systems and equipment

### **i** NOTE

- Before remotely stopping the engine, make sure that the vehicle is locked. If you are not sure about it, press the button  once, and then press and hold the button  to remotely stop the engine.
- To remotely stop the engine, keep the key within the effective range. Otherwise the unlocking function may be triggered and then the engine cannot be started.
- The maximum holding time for starting is about 5 min by default. If you need to change the duration, please go to the GAC Motor authorized shop to change it.

### Battery replacement



Every time you press the button on the remote control key, the indicator lamp of the remote control key will flash once. If the indicator lamp fails to flash, or you need to press it several times to lock or unlock the doors, the battery may be exhausted or about to be exhausted. If you need to replace the battery, it is recommended to go to the GAC Motor authorized shop for the replacement.

### **👁** CAUTION

- Be sure to replace the battery with a new one of the same model.
- An inappropriate battery may damage the remote control key.
- Always comply with relevant environmental regulations to dispose of the exhausted battery.

### Battery replacement steps



- Press the lock button  and pull out the emergency mechanical key  in the direction of the arrow.

## 4. Operation of systems and equipment

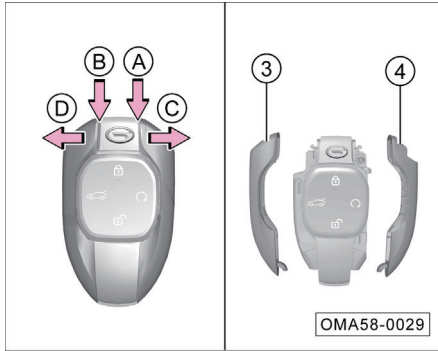

- Use a slotted screwdriver wrapped by cloth to pry open the chrome plated housing of the remote control key at positions (arrows A and B) in the direction of arrows C and D.
- Remove the chrome plated housings ③ and ④ of the remote control key.

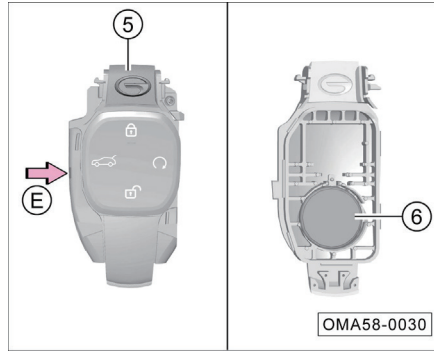

- Remove the transparent trim cover ⑤.
- Use a slotted screwdriver wrapped by cloth to pry open the housing of the remote control key at position (arrow E).
- Take out the remote control key battery ⑥.
- Assemble the remote control key in the reverse steps mentioned above.

### 4.2.2 Emergency mechanical key

#### Emergency mechanical key

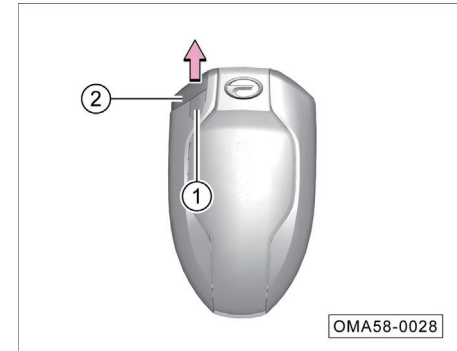

- Press the lock button ① and take out the emergency mechanical key ② in the direction of the arrow.



## 4. Operation of systems and equipment

### 4.2.3 Door lock system

#### Central locking button



The central locking button ① can be used to lock and unlock the doors in the vehicle:

- Lock all the doors: Press the  button of ①.
- Unlock all the doors: Press the  button of ①.

#### Door inner handle



- If the vehicle is locked, pull the inside handle of any door once to unlock that door only; Pull the door inside handle again to open the door.
- If the vehicle is unlocked, pull any door handle once to directly open the door.

#### NOTE

When the child safety lock is activated => See page 54, even if the rear door latch is unlocked, the inside handle cannot open the rear door. In this case, the rear door shall be opened from outside. And do not pull the inside handle with force to avoid damages.

#### CAUTION

- Before driving the vehicle, make sure that all doors are properly closed and locked.
- Do not pull the inside handle during driving to avoid accidents when the door is opened.
- When opening or closing the door, check the surroundings of the vehicle, such as whether the vehicle is on a slope, whether there is enough space to open the door and whether there is strong wind. When opening or closing the door, hold the door handle tightly for any unpredictable movement.



## 4. Operation of systems and equipment

### Door lock hole

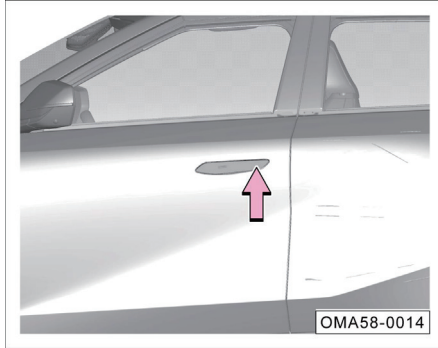

- Remove the emergency mechanical key.  
=> See page 51
- Press the left side of the door handle in the direction of -arrow A- to make the right side of the door handle tilt out, and then pull the handle out at a certain angle in the direction of -arrow B.

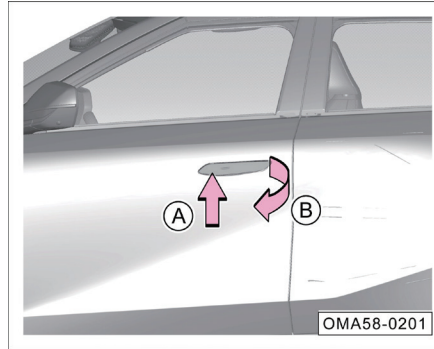

- Extend the handle of the mechanical key.

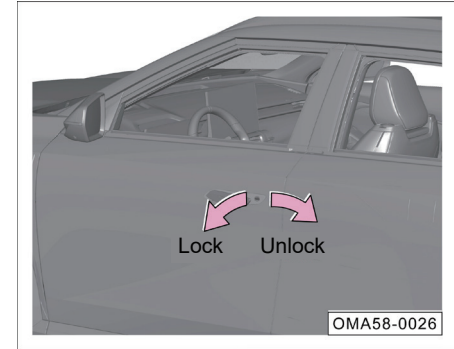

- Insert the emergency mechanical key into the driver's door lock hole.
- Turn the handle of the mechanical key clockwise to unlock the driver's door.
- Turn the handle of the mechanical key counterclockwise to lock all the doors.

## 4. Operation of systems and equipment

### Mechanical child safety lock \*

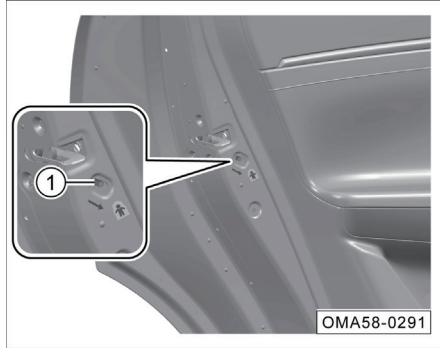

- Activation: Move the child safety lock switch ① as arrowed to locking position to activate the child safety lock.
- Deactivation: Move the child safety lock switch ① in opposite direction to the arrow to unlocking position to deactivate the child safety lock.

### Electronic child safety lock \*

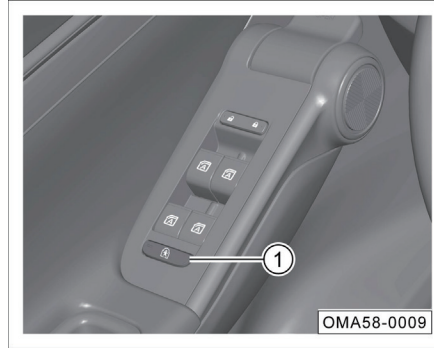

- Activation: Press the electronic child safety lock switch ① to light the button indicator lamp and activate the electronic child safety lock.
- Deactivation: Press the electronic child safety lock switch ① again to turn off the button indicator lamp and deactivate the electronic child safety lock.

### i NOTE

Electronic child safety lock button is integrated with rear passenger's window locking function. After the electronic child safety lock is activated, the rear passenger's power window control button cannot effectively operate the corresponding window.

### i NOTE

- Before driving the vehicle, if a child is seated in the rear seat, make sure that the child safety lock is activated.
- When the child safety lock is activated, the rear door cannot be opened by operating the inside handle. In this case, the rear door shall be opened from outside. And do not pull the inside handle with force to avoid damages.

## 4. Operation of systems and equipment

### WARNING

**When the child safety lock is activated, never leave children or handicapped persons in the vehicle alone. Once the doors are locked, it is difficult for children or handicapped persons to leave the vehicle in an emergency; locked doors in an accident will make it more difficult to rescue persons inside the vehicle.**

### Automatic unlock function

If the vehicle stops with the doors locked and the ENGINE START/STOP button set to "OFF" position, the four doors will be automatically unlocked.

### NOTE

The automatic unlock function can be activated or deactivated via "Settings → Body Accessories → Door/window lock → Automatic unlock function" in the AV system.

### Speed sensing door lock

If this function is activated with all doors closed, the vehicle will be automatically locked at certain vehicle speed or after certain driving time.

### NOTE

- This function is deactivated by default. Please read the above related content before activating this function.
- This function can be activated or deactivated via "Settings → Body Accessories → Door/window lock → Speed Sensing Door Lock" in the AV system.

### Collision unlock function

With doors locked and the ENGINE START/STOP button set to "ON" position, when the system detects that the vehicle has suffered a severe collision, all doors will be automatically unlocked. Depending on the impact force and impact range, the system may not work under extreme conditions.

### Intelligent active unlocking

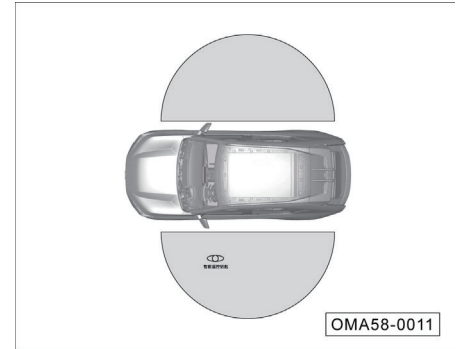

- When the intelligent active unlocking function is activated and the intelligent remote control key is brought to the area within 1.2 m of the vehicle, the vehicle will be automatically unlocked, and the exterior rearview mirror will be automatically unfolding\*.

## 4. Operation of systems and equipment

---

### **i** NOTE

- This function can be activated or deactivated via “Settings → Body Accessories → Door/window Lock → Intelligent Active Unlocking” in the AV system.
- After the intelligent active unlocking is successful, the turn signal lamps will flash twice and the horn will sound twice.
- When the vehicle has been not in use for more than 7 days, the intelligent active unlocking function will be automatically deactivated in order to reduce the power consumption of the vehicle, and in this case, you need to use the intelligent remote control key or touch the door handle to unlock the doors, and after the vehicle is started, the intelligent active unlocking function will be restored.

### Intelligent active locking

- With the intelligent active locking function activated and the ENGINE START/STOP button set to “OFF” position, after all doors are closed, if the intelligent remote control key is taken away from the vehicle to an area within 2 m from the vehicle for more than 2 min or to an area more than 2 m away from the vehicle, the vehicle will be automatically locked and the exterior rearview mirror will be automatically folded\*.
- If the key remains in an area within 2 m from the vehicle for more than 2 minutes, the system will temporarily deactivate the intelligent active locking function for the purpose of power saving; the user needs to open and then close one of the doors to re-activate the intelligent active locking function.

### **i** NOTE

- This function can be activated or deactivated via “Settings → body Body Accessories → Door/window Lock → Intelligent Active Locking” in the AV system.
- After the intelligent active locking is successful, the turn signal lamps will flash once and the horn will sound once.
- If the intelligent active locking is activated successfully but the liftgate is ajar, the audible and visual alarms will be triggered to remind you.

## 4. Operation of systems and equipment

The intelligent active locking function will not work when one of the following conditions occurs:

- The ENGINE START/STOP button is set to "ACC" or "ON" position.
- The intelligent remote control key is in the car.
- No intelligent remote control key is detected within 2 m from the vehicle.
- The intelligent remote control key is thrown into the vehicle from the door window.
- The intelligent remote control key is in the trunk.
- Any door is ajar.
- The battery voltage is low.
- The PEPS antenna is faulty.

### CAUTION

Please be careful not to leave children or disabled people in the vehicle when using the intelligent active locking function.

### 4.2.4 Flush-fit door handle

Electric flush-fit door handle \*

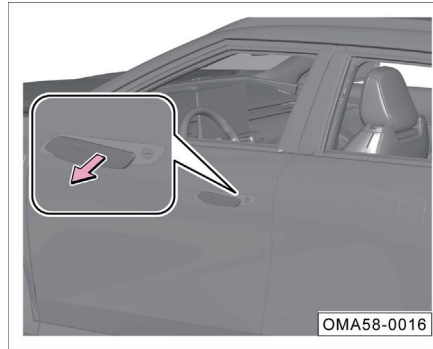

Unlock the vehicle, and after the electric flush-fit door handle unfolds automatically, pull the handle to open the door.

### NOTE

The electric flush-fit door handle function can be activated or deactivated via "Settings → Body Accessories → Door/window Lock → Electric Flush-fit Door Handle" in the AV system. Manually unfold the door handle after closing. => See page 53

When using the flush-fit door handle, please read and observe the following precautions:

### CAUTION

Stow the flush-fit door handle before washing the vehicle, so as to avoid water entry into the inside of door handle during washing and thereafter vehicle damage.

### WARNING

**Prevent hand pinching by door handle when locking the vehicle.**

## 4. Operation of systems and equipment

### Ice-breaking operation guide on flush-fit door handle at low temperature

When the key is close to the vehicle, the vehicle will automatically detect the remote control key. At this time:

Method 1:

Applicable to electric flush-fit door handle:

1. If a small amount of ice accumulates between the door handle and the door, the door handle can be electrically unfolded. At this time, please press the remote control key to electrically unfold and fold the door handle 3 times to remove the residual ice.
2. If there is a lot of ice accumulated between the door handle and the door, and the door handle cannot be electrically unfolded, you can manually press the tail end of the handle to make the tail end of the handle tilt up to break ice. If the handle still cannot be electrically unfolded, you need to manually deice with the following operations:

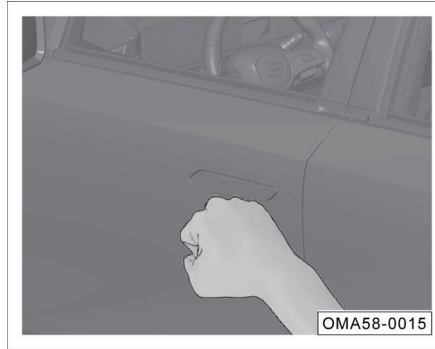

- Hit the circumference of the door handle with a slight force from the bottom of the fist to destroy and release the accumulated ice, and electrically unfold the door handle by pressing the remote control key.
- Repeat the steps by increasing the force as needed.



### WARNING

**The force of hitting the circumference of the door handle must not approximately cause dent of the door sheet metal.**

3. After the door handle can be moved, unfold and fold the door handle several times to remove the residual ice and ensure that the door handle can be fully retracted in place.

Method 2:

Pour hot water to break the ice.

### 4.2.5 Door

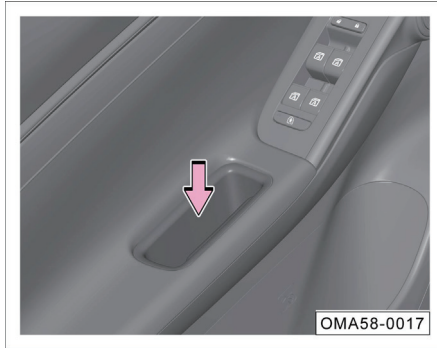

- To close the door in the vehicle, grab the door handle and pull it inward.
- To close the door outside, directly push the door toward the vehicle.

#### CAUTION

Before opening the door, always pay attention to other vehicles or pedestrians outside the vehicle to avoid accidents caused by collision.

#### WARNING

- **Make sure all doors are closed before driving, otherwise unclosed doors will open and cause accidents or injuries.**
- **Open or close the doors only when the vehicle is stationary.**
- **Do not put your hands on the edge of the door when closing the door, otherwise there will be a risk of pinching.**

#### NOTE

- If the door is not closed properly, please re-open the door and close it again.
- If the door is ajar, there will be a corresponding indication on the instrument cluster.

### 4.2.6 Liftgate

#### Unlocking liftgate with remote control key

If the vehicle has the PLG function, two presses on the button  of the remote control key within the effective range will make the liftgate automatically open to the set position. During opening, if you press this button again, the liftgate will stop opening.

If the vehicle does not have the PLG function, two presses on the button  of the remote control key within the effective range will unlock the liftgate with the need of manual opening of the liftgate.

## 4. Operation of systems and equipment

### Operation of outside button of liftgate \*

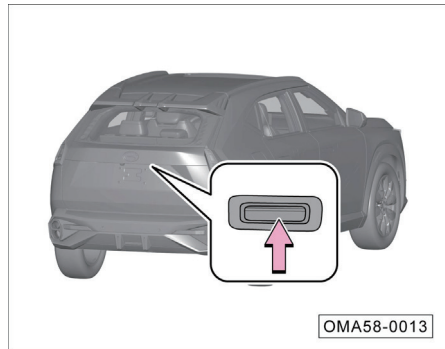

If you carry the intelligent remote control key, which is in the effective range, press the liftgate unlocking button to unlock the liftgate.

- If the vehicle does not have the PLG function, the liftgate needs to be opened manually.
- If the vehicle door has the PLG function, the liftgate will automatically open to the set position. During opening, if you press this button again, the liftgate will stop opening.

### i NOTE

When the vehicle is unlocked and stationary, if you press the liftgate unlocking button directly without carrying the intelligent remote control key, the liftgate will also be unlocked and opened.

### Operation of instrument desk buttons.

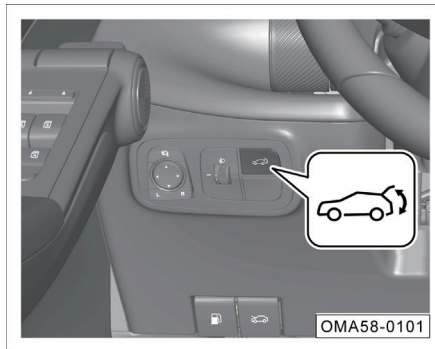

Press and hold the liftgate button to unlock the liftgate.

- If the vehicle does not have the PLG function, the liftgate needs to be opened manually.

- If the vehicle has the PLG function, the liftgate will automatically open to the set position. During opening, if you press this button, the liftgate will stop opening.

### Operation of inside switch of liftgate \*



- Press the inside switch of the liftgate to electrically close the liftgate.
- In this process, press the inside switch again to suspend opening/closing of the liftgate.



## 4. Operation of systems and equipment

Setting of second height of liftgate:

When the height of opening of liftgate is 55%~98%, press and hold the inside switch of liftgate for about 2 s to set the second height of liftgate successfully, which will be indicated by two sounds of the buzzer.

### CAUTION

As the inside switch of liftgate sends an action signal that does not identify opening or closing, the liftgate will confirm the relevant action according to the current state and the last action. If the opening action was previously suspended, pressing the inside switch will close the liftgate; and vice versa.

### Easy open of PLG \*

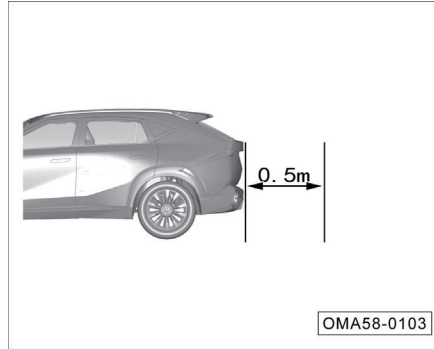

- With the ENGINE START/STOP button set to "OFF" position and the four doors and liftgate closed, if you take the intelligent remote control key to enter the induction area within about 0.5 m from the liftgate, the horn will sound once and the high-mounted stop lamp will start to flash, and if you stay there or take a step back, the liftgate will be automatically opened with the turn signal lamps flashing. If you leave the induction area when the high-mounted stop lamp flashes (4 times), the liftgate will not be opened.

### NOTE

- When the liftgate is automatically opened, the horn will sound once, the high-mounted stop lamp will flash 4 times, and the turn signal lamps will flash twice.
- If you leave the liftgate induction area when the high-mounted stop lamp is flashing, this function can be paused, and the liftgate will not be opened.
- If you press the button  on the intelligent remote key when the high-mounted stop lamp is flashing, this function can be paused, and the liftgate will not be opened. To re-activate the easy open of liftgate function, you need to open and then close one door.
- This function can be activated or deactivated via "Settings → Body Accessories → Door/window Lock → Easy Open of Liftgate" in the AV system.

## 4. Operation of systems and equipment

### CAUTION

- When washing the vehicle, make sure that the intelligent remote control key is outside the liftgate induction area; otherwise the liftgate will be opened. Therefore, it is recommended to deactivate this function in this case.
- If you pick up something near the liftgate while carrying the intelligent remote control key, please note that the liftgate may be opened.
- Before activating the easy open function to open the liftgate, make sure that no one or obstacle is within the movement range of the liftgate.

### Emergency opening of liftgate

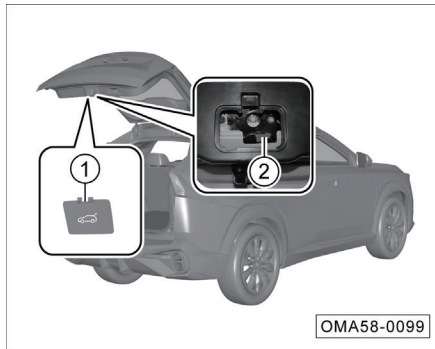

When the vehicle is out of power or the liftgate fails to be opened normally, please try the emergency interior opening of liftgate:

1. Lay down the rear seat backrest. => See [page 88](#)
2. Open the liftgate trim cover ①.
3. Operate the emergency switch ② of the liftgate to unlock and open the liftgate in case of an emergency.

### Closing of liftgate



#### PLG closing\*

- If you press the liftgate locking button, the PLG will be automatically lowered until it is closed. In this case, if you press this button again during the closing process, the PLG will stop at the current position.

#### Manual closing

When the liftgate does not have an electric function or the electric function fails, the liftgate can be closed manually:

- Lower the liftgate to the position close to the rear bumper cover, and then press down the liftgate firmly with both hands to close it.

## 4. Operation of systems and equipment



### CAUTION

During the closing of the liftgate, never place your hands or any part of your body in the area where the liftgate is closed to avoid pinching.

### NOTE

- When the PLG is electrically closed from standstill, the turn signal lamp flashes twice and the buzzer sounds.
- When the PLG is closed, the buzzer will sound intermittently.
- If the liftgate is ajar, there will be a corresponding indication on the instrument cluster.

### CAUTION

- The PLG must always be closed fully, otherwise accidents may easily occur.
- Be careful when closing the liftgate to ensure that no person or obstacle is within the movement range of the liftgate.
- Always ensure that the closed PLG is locked to prevent suddenly opening during driving.

## 4. Operation of systems and equipment

### 4.2.7 Engine hood

#### Opening of engine hood

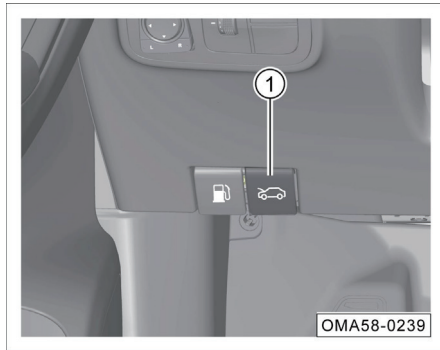

- If the engine hood release handle ① is pulled, the engine hood will be unlocked and pop up slightly.

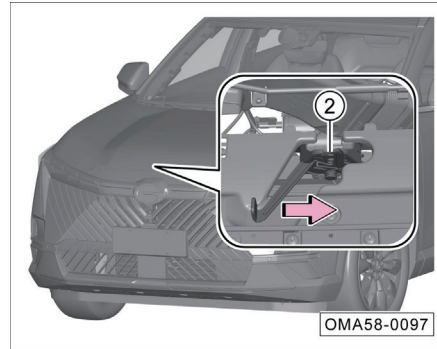

- If the locking mechanism ② is pushed as arrowed, the engine hood will be fully unlocked.

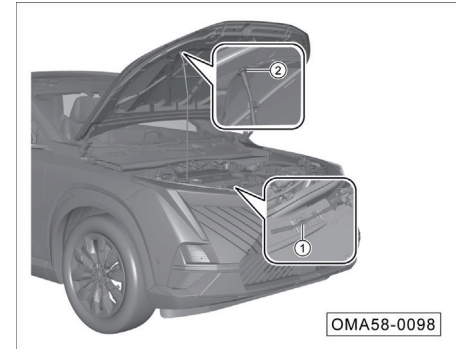

- Lift the engine hood to the limit position, take out the stay bar from the stay bar bracket ①, and fix the stay bar in the fixing hole ② to support the engine hood in the limit position.

### Closing of engine hood

- Take out the stay bar from the fixing hole ② and place it on the stay bar bracket ①; Lower the hood to a height of about 30 cm away from the lock body, and then let go to allow the hood to fall freely and then be locked.

#### WARNING

- Before driving, ensure that the engine hood is closed and locked, otherwise, it may suddenly open during driving, resulting in dangerous accidents.
- If the engine hood is ajar, the instrument cluster display will display an alarm message. In this case, please stop driving immediately and close and lock the engine hood correctly.

### 4.2.8 Power windows

The power window can be operated when the ENGINE START/STOP button is in the "ON" position. It stays operable within about 30 s after the ENGINE START/STOP button is switched from the "ON" position to the "ACC" or "OFF" position, but will become inoperable if any one of the doors is opened within this about 30 s.

#### CAUTION

- Please close all windows before leaving the vehicle.
- Be careful when closing the window. Do not put your hand on the edge of the window, otherwise there is a danger of pinching injury.

### Driver's power window control button

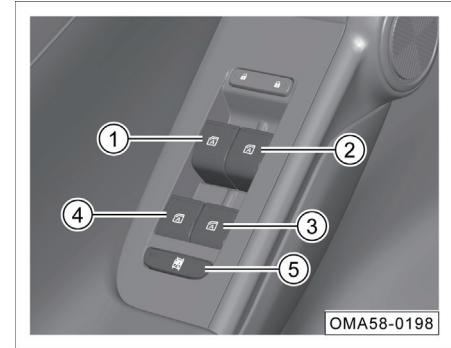

- ① Left front power window control button
- ② Right front power window control button
- ③ Right rear power window control button
- ④ Left rear power window control button
- ⑤ Passenger's power window control button  
\*electronic child safety lock button \*

## 4. Operation of systems and equipment

- If the button ① is pulled up to the first stop position, the power window will be lifted for closing until the button is released or the window reaches the highest position.
  - If the button ① is pulled up to the limit position, the power window will be lifted automatically for closing until the window reaches the highest position.
  - If the button ① is pressed down to the first stop position, the power window will be lowered for opening until the button is released or the window reaches the lowest position.
  - If the button ① is pressed down to the limit position, the power window will be lowered automatically for opening until the window reaches the lowest position.
- If you press the passenger's window lock button ⑤\*, the button indicator lamp will come on, and the front and rear passengers' power window control buttons cannot effectively operate the corresponding windows. To unlock, press the button again and the button indicator lamp goes out.
  - Press the electronic child safety lock button ⑤\*, the button indicator lamp lights up, and the rear passenger's power window control button cannot effectively operate the corresponding window. To unlock, press the button again and the button indicator lamp goes out.

### **i** NOTE

- If you want to stop the window during the automatic lifting or lowering process, just press down/pull up the button ①.
- The operation methods of the buttons ②, ③ and ④ are the same as that of the button ①, only corresponding to the respective windows.

### Passenger's power window control button

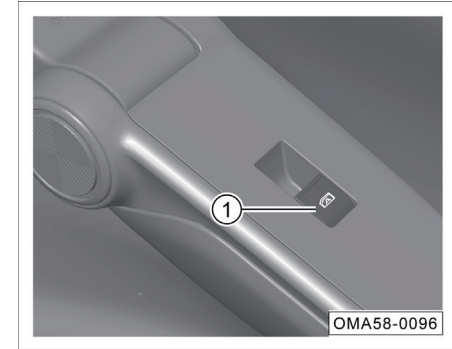

- Refer to the driver's power window control button for the use method of the passenger's power window control button ①.

## 4. Operation of systems and equipment

### Locking-sensitive window closing function \*

If you close and lock the doors without closing the windows (door locking by remote control key, intelligent active locking, or Bluetooth locking\* when you leaving the vehicle), the system will automatically close the windows to prevent the vehicle from being damaged. This function can be activated or deactivated via “Settings → Body Accessories → Door/window Lock → Locking-sensitive Window Closing” in the AV system. If the window fails to be closed automatically due to abnormal conditions such as activation of anti-pinch function, the horn will sound 4 times to remind the user that the window closing fails.

#### CAUTION

The locking-sensitive window closing function is effective only when the battery level and other relevant parts are normal. Do not leave the vehicle until it is confirmed that the windows are fully closed.

### Automatic window calibration \*

If the window cannot be automatically raised due to external reasons, the window will be lowered to the bottom for automatic calibration, and then the window will be automatically raised.

#### CAUTION

Under special circumstances, an individual window may not be automatically lifted, and in this case, users are required to manually lift windows for calibration.

### Window open warning \*

When the ENGINE START/STOP button is turned to the “OFF” position with any window open, if you open the driver’s door, the system will send a buzzer sound and the instrument cluster display will display the message “Window open”.

### Initialization of anti-pinch function \*

If the express-up function is not available, or the anti-pinch function fails, or the initialization becomes invalid automatically because the anti-pinch function is triggered multiple times in a short period of time, the power window needs to be initialized again.

1. Pull up the power window control button, and then the window is lifted in steps until it is completely closed.
2. After the window is completely closed, continue to pull up the power window control button for about 2 s for initialization.
3. After the initialization of the corresponding window is completed, lower the window to the bottom and press and hold the power window control button for about 2 s to make the window reach the hard stop.
4. Lift the power window control button and check whether the express-up function is available.

## 4. Operation of systems and equipment

### WARNING

- The window has no anti-pinch function during the initialization learning process. Therefore, please do not use any part of your body or other objects to hinder the closing of the window, otherwise it will cause personal injury and affect the result of the initialization learning.
- If the power window system fails, please go to the GAC Motor authorized shop for inspection and repair in time.

### 4.2.9 Electric sunshade\*

#### Button operations

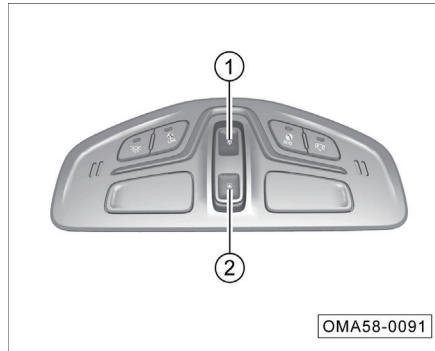

- If you press the switch ①, the electric sunshade will move a short distance for slight opening and then stop.
- To close the electric sunshade slightly, press the switch ②, and then the electric sunshade will move in the closing direction for a short distance and then stop.

- To fully open the electric sunshade, press and hold the switch ① for several seconds, and then the electric sunshade will automatically move to the fully opened position.
- To fully close the electric sunshade, press and hold the switch ② for several seconds, and then the electric sunshade will automatically move to the fully closed position.

### NOTE

If the switch is pressed during the automatic opening or closing of the electric sunshade, the electric sunshade will stop at the current position.

### CAUTION

Do not touch the sunshade with hand or object when it is opening or closing; otherwise, the sunshade may incur wrinkle, dislodgement or even failure.





### Remote control

- When you press and hold the button  on the remote control key with the ENGINE START/STOP button set to "OFF" position, the sunshade will be closed, and if you release the button during closing, the sunshade will stop.

### AV system display control



On the AV system display, the sunshade switch is controlled by clicking the soft keys such as , , "sunshade fully open" and "sunshade fully closed" in the intelligent scene "car model" or the application menu "My car".

### Electric sunshade anti-pinch function

The electric sunshade has anti-pinch function when sliding closed to prevent the sunshade from catching large items when closed.

- When the electric sunshade is in the sliding area, if the anti-pinch function is triggered, the electric sunshade will move a certain distance in the direction of opening and then stop moving.

### CAUTION

Do not operate the electric sunshade when the ambient temperature is below  $-20^{\circ}\text{C}$ , at which the anti-pinch function of the electric sunshade may not be activated, resulting in accidents. In addition, the low temperature will also damage the motor to a certain extent.

### WARNING

- The anti-pinch function of the sunshade cannot prevent pinching of light or thin objects.
- Be careful when closing the sunshade, and make sure that no one is within the range of motion of the sunshade closing to avoid being pinched.
- The sunshade will stop detecting obstacles at a position where the sunroof is about to be closed fully, so the anti-pinch function will be deactivated at this time.
- Do not try to activate the anti-pinch function by your hand or any part of your body, otherwise there will be a risk of pinching.

## 4. Operation of systems and equipment

### Electric sunshade initialization



- Press the sunshade closing switch ①, so that the sunshade will run to the fully closed position.
- Continuously press the sunshade closing switch ①, so that the sunshade will be opened a certain distance first, and then finally run to the fully closed position.
- Release the sunshade closing switch ①, so that the sunshade initialization will be completed.

### 4.2.10 Basic operation of body anti-theft system

#### Body anti-theft function - remote unlocking

When the ENGINE START/STOP button is in the "OFF" position and the vehicle is in the anti-theft state, if you bring the intelligent remote control key to approach the vehicle doors and press the unlocking button on the remote control key, all the doors will be unlocked to release the vehicle from the anti-theft state, and the turn signal lamps will flash twice.

#### Body anti-theft function - remote locking

When the ENGINE START/STOP button is in the "OFF" position and the four doors, engine hood and liftgate are closed, if you take the intelligent remote control key away from the vehicle and press the locking button on the remote control key, all the doors will be locked to enable the vehicle to enter the anti-theft state, and the turn signal lamps will flash once.

#### Activation of body anti-theft function

When the ENGINE START/STOP button is in "OFF" position and the vehicle is armed, if the door is unlocked by an illegal key or is forcibly unlocked, the anti-theft system will be activated, the anti-theft horn will sound and the turn signal lamps will flash.

When the vehicle is locked by remote control and enters the anti-theft state, if the driver's door is unlocked with the emergency mechanical key, the anti-theft system will trigger the horn to sound and the turn signal lamps will flash.

#### **i** NOTE

Before or during the anti-theft alarm is triggered, if you press the button on the remote control key or switch the ENGINE START/STOP button to the "ON" position, the anti-theft alarm will be disabled and the vehicle will be released from the anti-theft state;  The alarm can be triggered up to 10 times in one cycle.

### Engine immobilizer

When the ENGINE START/STOP button is switched from the “OFF” position to the “ON” position with the body anti-theft state released and the legal key in the vehicle, if the engine immobilizer system passes the verification, it will be deactivated.

If the engine immobilizer system does not pass the verification, the engine cannot be started and an immobilizer alarm will be triggered.

### Body anti-theft maintenance instructions

No maintenance is required during normal use. If you have any doubt, please contact the GAC Motor authorized shop.

## 4.3 Lamps and vision

### 4.3.1 Exterior lamps

#### Lamplight combination switch

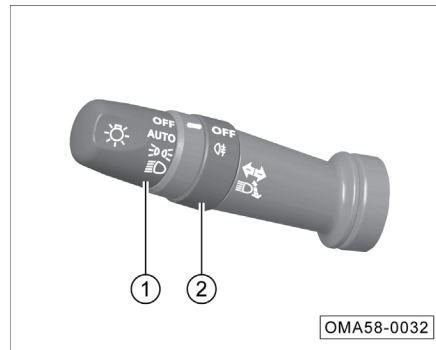

① Lamplight switch

② Fog lamp switch

### i NOTE

- Water vapors or even water drops may appear on the inner surfaces of the lamps under certain conditions (such as high air humidity and after vehicle washing), which is similar to the fogging phenomenon on the windows when the vehicle is traveling in the rain, and does not constitute a malfunction.
- This fogging phenomenon can be eliminated by parking the vehicle in a dry environment, turning on the lamps or driving the vehicle, but may recur.
- If there are a lot of water drops or water ingress in the lamps, please contact the GAC Motor authorized shop for inspection.

### i NOTE

The figure shows the model with automatic headlamp on/off as an example, and the specific function switches shall be subject to the real vehicle.

## 4. Operation of systems and equipment

### Turn signal lamp

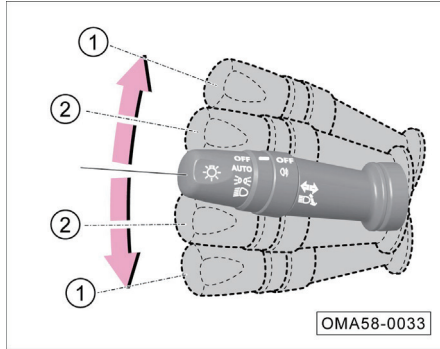

- When the ENGINE START/STOP button is in the “ON” position, if you turn the lamplight combination switch up or down to the limit position ① and turn on the right or left turn signal lamp, the corresponding indicator lamp ➡ or ⬅ on the instrument cluster will flash.

### Turn signal lamp flashing for lane change

- In case of lane changing or overtaking, if you quickly turn the lamplight combination switch up or down to the position ② and then release it to the original position, the corresponding turn signal lamp and the indicator lamp ➡ or ⬅ on the instrument cluster will flash 3 times.

- If you turn the lamplight combination switch up or down and hold it at the position ②, the corresponding turn signal lamp and the indicator lamp ➡ or ⬅ on the instrument cluster will flash continuously. Releasing the switch to the original position can stop the flashing.

### CAUTION

If the corresponding indicator lamp ➡ or ⬅ on the instrument cluster flashes faster, one of the turn signal lamps may be faulty, please go to the GAC Motor authorized shop for inspection and repair in time.

### Lamplight switch

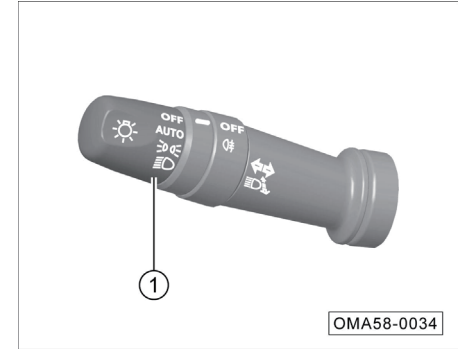

When the ENGINE START/STOP button is in the “ON” position, turn the lamplight switch ① to activate or deactivate AUTO (automatic headlamp on/off function)\*, ② (position lamp), and ③ (low beam).

When the lamplight switch is turned to the “OFF” position, all lamps will go out.

## 4. Operation of systems and equipment

### AUTO (automatic headlamp on/off)\*

- Turn the lamplight control switch to the AUTO position to activate the automatic headlamp on/off function.

#### **i** NOTE

If the automatic headlamp on/off function is activated, the vehicle will automatically turn on or off the headlamp according to the ambient light. When the ambient light gradually becomes dark, the position lamps and the low beam will be turned on simultaneously; when the ambient light gradually becomes bright, the position lamps and the low beam will be turned off simultaneously.



#### CAUTION

- If the instrument cluster displays “Sensor Failure, Please Manually Control Light”, the system will keep the low beam on for the sake of safety. At this time, you should manually control the light and go to the GAC Motor authorized shop for inspection and repair in time.
- The automatic headlamp on/off function may be affected in the haze environment, so please manually turn on the headlamp in this case.

### Daytime running lamp \*

- When the engine is started and the position lamps are off, the daytime running lamps will be automatically turned on; After the low beam is turned on or the engine is turned off, the daytime running lamp is automatically turned off.

### Position lamp

- If you turn the lamplight switch to the position , the position lamps, instrument panel lamps, license plate lamps and other lamps will be turned on, and the corresponding indicator lamp  on the instrument cluster will come on.

## 4. Operation of systems and equipment

### NOTE

If you forget to turn off the position lamps when the ENGINE START/STOP button is set to the "OFF" position and the vehicle is not locked, the position lamps will stay on for about 15 min and then go out automatically in order to save the battery power; when the ENGINE START/STOP button is set to the "OFF" position and the vehicle is locked, the position lamps will go out immediately.

### WARNING

- **When driving the vehicle at night or on a road with poor visibility, also use other lamps in addition to the position lamp. Otherwise, accidents may easily occur.**
- **When temporarily parking the vehicle at night or on a road with poor visibility with the need of indicating the position of the vehicle, do not use the position lamps as the parking lamps but be sure to turn on the hazard warning lamp due to the battery power saving function of the position lamps.**

### Low beam

- Rotate the lamplight switch to the  position to turn on the low beam.

### High beam

- After turning on the low beam, if you push the lamplight combination switch forward to the limit position, the high beam will be turned on and the corresponding indicator lamp  on the instrument cluster will come on.
- If you pull the lamplight combination switch backward to the original position, the high beam will be turned off.

### Headlamp flashing

- If you pull the lamplight combination switch backward to the limit position, the high beam will be turned on.
- If you release the switch, the lamplight combination switch will automatically return to its original position and the high beam will be turned off.

### NOTE

- The high beam may cause dazzling to drivers of oncoming vehicles at close range and possibly result in an accident thereafter. Therefore, please use the high beam reasonably.
- When all the lamps are turned off, if you pull and hold the lamplight combination switch backward, the high beam will stay on, and the corresponding indicator lamp  on the instrument cluster will come on.

## 4. Operation of systems and equipment

### Manual headlamp leveling



Turn the knob ① to manually level the headlamp (low beam) at “0, 1, 2 and 3” positions. The level of the headlamp will decrease as the adjustment value increases.

### Lamp on warning

When the ENGINE START/STOP button is set to the “OFF” position with the headlamps or position lamps on, if you open the driver’s door, the system will send a buzzer sound and the instrument cluster display will display the message “Lamp On”.



### Follow Me Home

- Within 10 minutes after switching the power supply switch to the “OFF” position, if you turn the lamp switch from the “OFF” position to other positions and then back to the “OFF” position within about 2 s, the Follow Me Home function will be activated. In this case, the low beam will stay on for about 30 s, if one of the doors (four doors, engine hood and liftgate) is opened within this 30 s, this function will be re-timed, and then the low beam will stay on for about 80 s, and if all the doors are closed within this 80, this function will be re-timed again, and then the low beam will stay on for another 30 s.
- Activate the front headlamp delay off function through the AV system “setting→body accessories→exterior lighting→headlamp delay off”. Set the lighting combination switch to “AUTO” position and set the power supply switch to the “OFF” position. In such a case, the low beam will stay on for about 30 s, if one of the doors (four doors, engine hood and liftgate) is opened within this 30 s, this function will be re-timed, and then the low beam will stay on for about 80 s, and if all the doors are closed within this 80, this function will be re-timed again, and then the low beam will stay on for another 30 s. (This applies to the automatic lighting vehicle models).

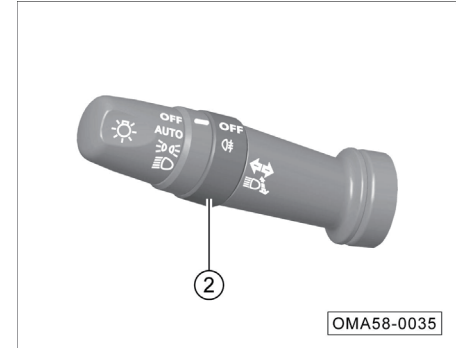
### Fog lamp switch





When the ENGINE START/STOP button is set to the “ON” position with the low beam on, turn the fog lamp switch ② to turn on or off  (rear fog lamp).

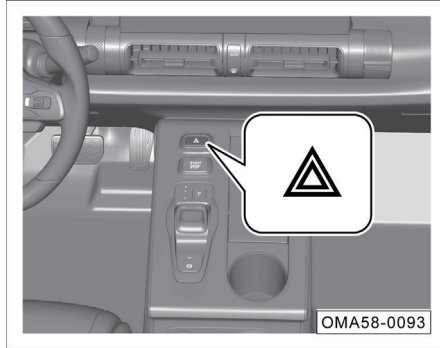

- After the fog lamp switch ② is turned to the position  and then released to the “—” position, the rear fog lamp will come on.
- When the fog lamp switch ② is turned to position  again and then released to return to position “—”, the rear fog lamp will go out.

## 4. Operation of systems and equipment

### Hazard warning lamp



If you press the switch  with ENGINE START/STOP button in any position, the red indicator lamp on the switch will flash and the hazard warning lamp will be turned on. Press this switch again to turn off the hazard warning lamp.

If the hazard warning lamp is turned on, all turn signal lamps and the indicator lamps  or  on the instrument cluster will flash simultaneously.



The hazard warning lamp shall be turned on in the following cases so as to attract the attention of persons on the road and reduce the risk of traffic accidents:

- The vehicle is involved in any failure.
- The vehicle is at the tail end of a traffic jam.
- The vehicle tows another vehicle or is towed.
- The vehicle is temporarily parked due to poor visibility.

### NOTE

- The use of the hazard warning lamp will consume the battery power, so please turn it off when not in use.
- Be sure to strictly abide by the relevant regulations when using the hazard warning lamp.
- In case of emergency, if the hazard warning lamp is faulty, other methods that comply with relevant traffic regulations must be taken to attract the attention of other people on the road.

### Vehicle assisted lighting

- If you press the unlocking button  on the remote control key within the effective range, the position lamps will stay on for a short time for purpose of helping you to approach your vehicle. If you press the unlock button  on the remote control key again, the position lamps can stay on for another period of time. When you get in the vehicle and switch the ENGINE START/STOP button to the "ON" position, the position lamps will go out.

### Vehicle locating lighting

- If you press the locking button  on the remote control key twice within a short time, the position lamps will stay on for a short time and the turn signal lamps will flash 3 times for the purpose of helping you to locate your vehicle.



### 4.3.2 Interior lamps

#### Automatic light-on function of dome lamps

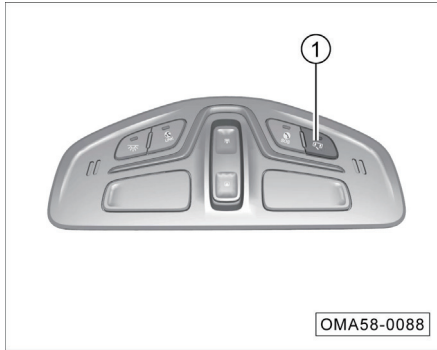

- Press the switch ①, so that the button indicator lamp lights up, and turn on the automatic light-on function of dome lamps; Press the switch ① again, so that the button indicator lamp is off, and turn off the automatic light-on function of dome lamps.

#### Interior light delay off

When the dome lamps are off and the automatic light-on function of dome lamps is activated:

- If the ENGINE START/STOP button is in the "OFF" position and one of the doors is opened, the dome lamps will come on automatically, and then go out about 30 s after the doors are closed.
- If the ENGINE START/STOP button is in the "OFF" position and the doors are unlocked by remote control, the dome lamps will come on automatically and then go out after about 30 s.
- If the ENGINE START/STOP button is switched from the "ON" position to the "OFF" position, the dome lamps will come on automatically and then go out after about 30 s.

#### **i** NOTE

When all the doors are closed and the dome lamps are on as mentioned above, if the vehicle is locked by remote control or the ENGINE START/STOP button is set to the "ON" position, the dome lamps will go out automatically.

#### Dome lamp



- When the dome lamps are off, press the switch ②, so that the button indicator lamp will light up, and all the dome lamps will light up; when the switch ② is pressed again, the dome lamps will go out.

#### **i** NOTE

The switch ② will be ineffective if it is not used to turn on the dome lamps.

## 4. Operation of systems and equipment

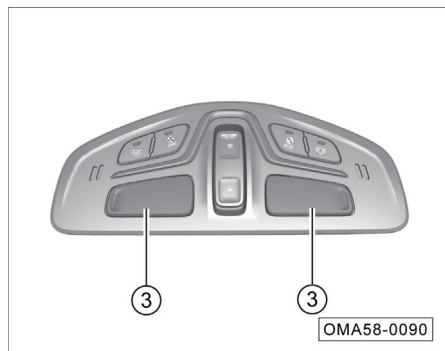

- When the front dome lamps are off, touch the front dome lamp switch ③ on the corresponding side to turn the front dome lamp on; touch it again to turn it off.

### **i** NOTE

The switch will be ineffective if it is not used to turn on the front dome lamps.

### Rear dome lamp

#### Type I

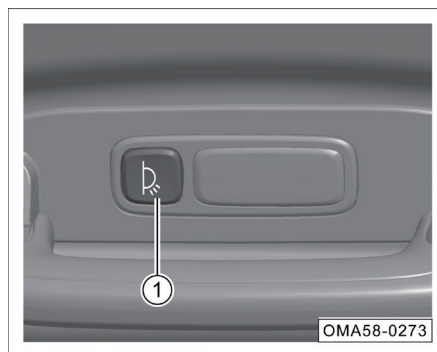

- When the rear dome lamps are off, press the switch ① to turn on the dome lamp on the corresponding side; press the switch ① again to turn it off.

### **i** NOTE

The switch ① will be ineffective if it is not used to turn on the rear dome lamps.

#### Type II

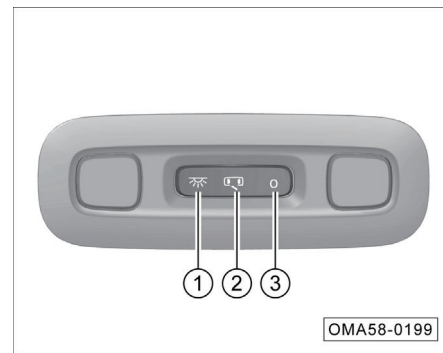

- When the rear dome lamps are off, press ① to turn on the rear dome lamps; press ③ to turn off the dome lamps.
- When the rear dome lamp switch is in the flat state, i.e. in the position ②, the rear dome lamps can be turned on by opening the door or pressing the front dome lamp switch.

### Trunk lamp

- If the liftgate is opened, the trunk lamp will come on automatically.
- If the liftgate is closed, the trunk lamp will go out automatically.

## 4. Operation of systems and equipment

### Smart ambient light\*

Click on the vehicle model in the main interface of AV system or “My Car” in the application menu to enter the My Car interface, and then select “Light Effect→Ambient Light” soft key to enter the interior ambient light effect setting interface.

Operation interface:

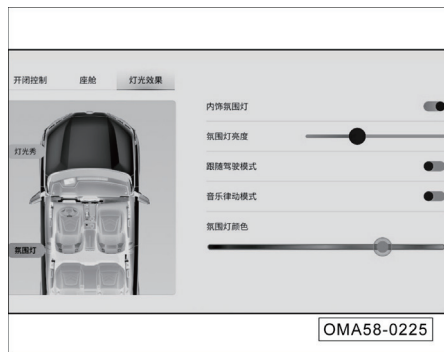

#### 1. Ambient light switch

- Click the right  soft key of “interior ambient light” to turn on or off the interior ambient light function.

- Other parameters cannot be adjusted when the ambient light function is turned off; when the ambient light function is activated with ENGINE START/STOP button in ON position, the ambient light stays on.
- 2. Ambient light brightness adjustment
  - You can adjust the brightness of ambient light by clicking or sliding the ambient light brightness progress bar.
- 3. Drive mode following switch
  - When the drive mode following function is activated, the color of the ambient light will change along with the drive mode. That is to say, when the user changes the drive mode, the ambient light color will change accordingly.
- 4. Ambient light color
  - Drag or click the color bar to select the ambient light color.

### 4.3.3 Wiper combination switch

#### AUTO position

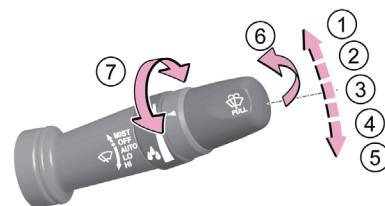

OMA58-0036

#### INT position

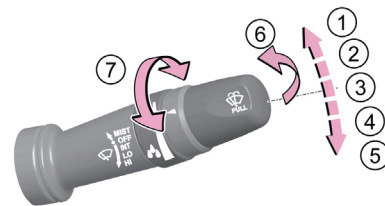

OMA58-0037

## 4. Operation of systems and equipment

When the ENGINE START/STOP button is in the "ON" position, the wiper combination switch can be operated as follows:

- ① MIST: inching
- ② OFF: front windshield wiper off
- ③ AUTO: automatic wiping \*
- INT: intermittent wiping\*
- ④ LO: wiping at low speed
- ⑤ HI: wiping at high speed
- ⑥ Front windshield washer system on
- ⑦ Adjusting knob:
- Adjust the sensitivity of automatic wiping (AUTO)\*
- Adjusting the intermittent wiping (INT) interval\*

### MIST: inching

- Turn the wiper combination switch from the initial position to the limit ① MIST position and then release it. The wiper combination switch will return to the initial position, and the front wiper motor will stop moving after wiping once.
- If the wiper combination switch is toggled from the initial position to the limit ① MIST position and then not released, the front wiper motor will always work.

### OFF: wiper off

- Toggle the wiper combination switch to the limit ② OFF position, so that the front wiper motor will stop wiping water.

### AUTO: automatic wiping \*

- If the wiper combination switch is turned to the ③ AUTO position, the automatic wiping function will be activated, and the wiper system will adjust the wiper speed according to the current rainfall and the real-time vehicle speed.
- The automatic wiping function can be activated or deactivated via "Settings → Body Accessories → Other Accessories → Automatic Wiper" in the AV system. When this function is deactivated, the function of the wiper in the AUTO position is equivalent to that in the INT position.
- Rotate the knob ⑦ up/down to adjust the wiping sensitivity.

### CAUTION

- If the instrument cluster displays "Sensor Failure, Please Manually Control Wiper", for the sake of safety, you should manually control the wiper and go to the GAC Motor authorized shop for inspection and repair in time.
- Before using the automatic wiping in winter, please confirm whether the wiper blade is frozen.
- It is recommended to deactivate the automatic wiping function when washing the vehicle, in dusty weather and in rainless weather to avoid unintentional action of the wipers which may cause damage or personal injury.
- Automatic wiping is an auxiliary function. The driver should manually operate the wiper when necessary according to the driving situation to ensure driving safety.
- When replacing the front windshield, the rain light sensor needs to be replaced together.
- When the sensor is installed with streaks, scratches and stains, it may cause automatic wiper misoperation.

## 4. Operation of systems and equipment

### INT: intermittent wiping\*

- If the wiper combination switch is turned to the ③ INT position, the front wiper will start wiping intermittently.
- For the models equipped with the automatic wiping function, this function can be activated via “Settings → Body Accessories → Other Accessories → Automatic Wiper” in the AV system.
- Adjust the intermittent wiping speed by turning the knob ⑦ up/down.

### LO: low speed wiping

- If the wiper combination switch is turned to the ④ LO position, the front wiper will wipe at a slow speed.

### HI: Quick wiping

- If the wiper combination switch is turned to the ⑤ HI position, the front wiper will wipe at a high speed.

### Front windshield washer system on

- If the wiper combination switch is turned toward the rear of the vehicle to the ⑥ position, the front washer will start spraying water and then the front wiper will start wiping.
- If the wiper combination switch is released to return to its original position, the front windshield washer system will be stopped and the front wiper will wipe once after about 6s.
- After the front wiper motor stops wiping for about 6 s, it will wipe again to remove the remaining water stains on the windshield.

### Front wiper maintenance

- Method 1: Within 10 s after switching the ENGINE START/STOP button to the “OFF” position, if you turn the control lever of the wiper combination switch to ① MIST position and then quickly release it to return it to the original position, the front wiper will move to the highest position and then stop, so that the wiper maintenance mode is activated.
- Method 2: When the ENGINE START/STOP button is in the “ON” position, click “Settings → Body Accessories → Other Accessories → Wiper Maintenance Mode” in the AV system to enter the wiper maintenance mode.

## 4.3.4 Windshield

### Windshield



The front windshield is made of green glass.

## 4. Operation of systems and equipment

### WARNING

- Always keep the glass surface clean.
- Please affix the necessary identifications according to local traffic laws, rules and regulations. Do not stick paper or hang objects on the surface of the front windshield, otherwise the front view will be obstructed, which may easily cause traffic accidents.

### 4.3.5 Rearview mirror

#### Interior rearview mirror

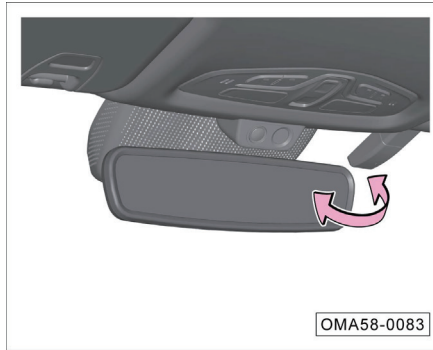

OMA58-0083

Auto anti-glare interior rearview mirror will monitor the intensity of light from the rear traffic in real time and automatically adjust the mirror reflection effect accordingly so as to soften the strong light to be reflected into the driver's eyes.

- Before driving, be sure to adjust the interior rearview mirror to the appropriate angle.
- Hold the interior rearview mirror and adjust it up and down and left and right to the best rearview position.

### WARNING

Do not adjust the interior rearview mirror during driving, as you will be distracted from driving, causing loss of control to vehicle and dangerous accident thereafter.

## 4. Operation of systems and equipment

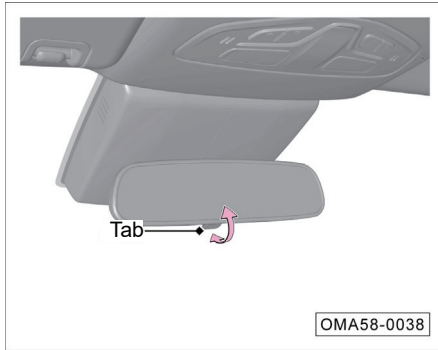

Manually adjusting the interior rearview mirror can reduce the light reflected off the mirror surface, thus realizing the optimal rear view.

- As shown in the figure, the tab is at a normal rearview angle, which can be pulled forward to offset the reflective light coming from the rear to achieve the anti-glare function.
- Push the tab backward to return to the normal rearview angle.

### Exterior rearview mirror

#### Electric adjustment

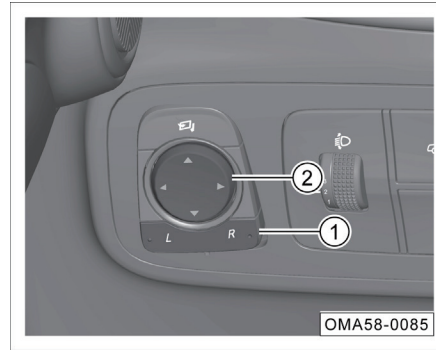

The exterior rearview mirror adjustment button is located at the lower left of the instrument panel.

- Press “L” or “R” button on the selection button ① to select the left or right exterior rearview mirror.
- Press the adjustment button ② to adjust the selected exterior rearview mirror to the appropriate rear view angle.
- After adjusting the exterior rearview mirror, restore the selection button ① to its original state.

### **i** NOTE

If the exterior rearview mirror function fails, please go to the GAC Motor authorized shop for inspection and repair in time.

### **⚠** WARNING

**Although the curved (convex and spherical) rearview mirror can expand the field of view, the reflected object image is smaller and farther than the real object. Therefore, when changing the lanes, do not judge the distance between your vehicle and the following vehicle by the reflected image, otherwise accidents may occur due to wrong judgment.**

## 4. Operation of systems and equipment

### Electric folding \*

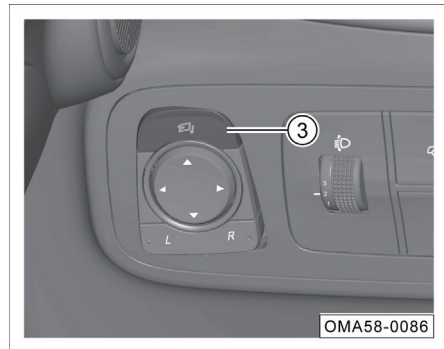

- Press the folding button ③ to perform electric folding of exterior rearview mirrors.
- Press the folding button ③ again to unfold the exterior rearview mirrors electrically.

### Automatic folding \*

- Lock the vehicle from outside and the exterior rearview mirror will be folded automatically.
- Unlock the vehicle from outside and the exterior rearview mirror will be unfolded automatically.

### i NOTE



This function can be activated or deactivated via "Settings → body accessories → exterior rearview mirror → automatic folding of exterior rearview mirror" in the AV system.

### 👁 CAUTION

- If the electric folding function fails or the vehicle does not have the electric folding function, the mirror can be folded manually. After manual folding, please restore it manually. A click sound can be heard when the mirror is manually unfolded.
- Do not manually fold the exterior rearview mirror with electric folding function frequently, otherwise the internal folding mechanism will be damaged and the electric folding function will fail.
- Be careful when operating the electric folding function of the exterior rearview mirror to prevent fingers from being pinched by the rearview mirror and its base.

### Defrosting and defogging function \*



Enter the A/C control main interface through the AV system display, and click  the soft key ① to turn on/off the function, and when the function is turned on, the indicator lamp  on the button goes on.

- Turn on defrosting and defogging function to remove fog or frost on the exterior rearview mirror and rear windshield.
- This function will be deactivated automatically after about 15 min or manually by pressing down  the soft key, and then the button indicator lamp will go out.



### CAUTION

- After defrosting and defogging function is automatically turned off, if the defog or frost still needs to be removed, press the button  again.
- Do not continuously use the defrosting and defogging function for a long time, otherwise the heater may be overheated and damaged.
- If there is no need to use defrosting and defogging function, please turn off this function to avoid wasting battery power.

### 4.3.6 Sun visor

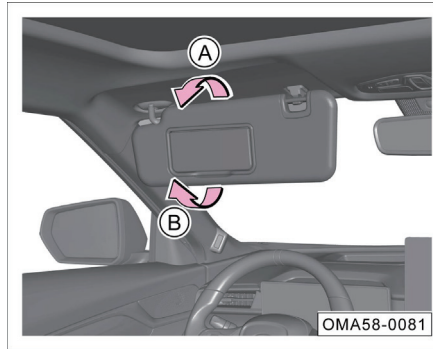

- Turn down the sun visor on the driver's side or front passenger's side in the direction of - arrow A - to block the sunlight from the front windshield.
- If you need to use the vanity mirror, turn down the sun visor and open the vanity mirror cover in the direction of arrow B.

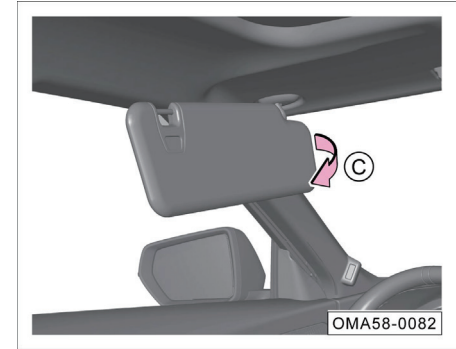

- After turning down the sun visor on the driver's side or front passenger's side, pull it out from the movable bracket on one side in the direction of - arrow C - to block the sunlight from the side window.

## 4. Operation of systems and equipment

### 4.4 Seats and storage facilities

#### 4.4.1 Headrest

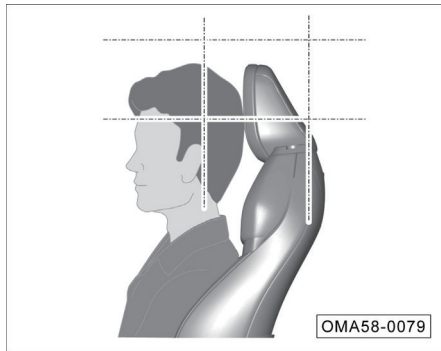

Correct adjustment of the headrests is essential to protect the occupants and reduce the personal injuries in accidents.

Always adjust the head restraint to the correct position (as shown in the figure) according to their body shape.

**⚠ WARNING**

In order to reduce the risk of accidental casualties, please strictly observe the followings:

- Do not adjust the headrest while driving.
- Always keep the headrest in its mounting position. If the headrest is removed or installed improperly, the driver and passengers will be seriously injured in the event of an accident.

#### Height adjustment of front seat headrests



- Downward adjustment: Press and hold the lock button ①, and press down the headrest to the desired position.
- Upward adjustment: Lift up the headrest directly to the desired position.

**i NOTE**

The adjustment method of rear head restraints is the same as that of front head restraints\*.

## 4. Operation of systems and equipment

### 4.4.2 Front seat

#### **i** NOTE

When measuring the depth of the seat cushion, be sure to adjust the longitudinal position of the seat to the middle of the slider rail and the seat back to the normal operating state (25°).

#### **⚠** WARNING

- **Do not place objects under the front seat. The objects may be caught between the seat and the guide rail and hinder the seat locking.**
- **Do not adjust the seats when the vehicle is running, which is very likely to cause casualties. The front seats can only be adjusted when the vehicle is stationary.**
- **Never leave children alone in the vehicle, because the power seat\* adjustment mechanism still works after the ENGINE START/STOP button is set to the “OFF” position, and if the children accidentally operate the power seat, it may cause an accident.**

#### Power seat\*

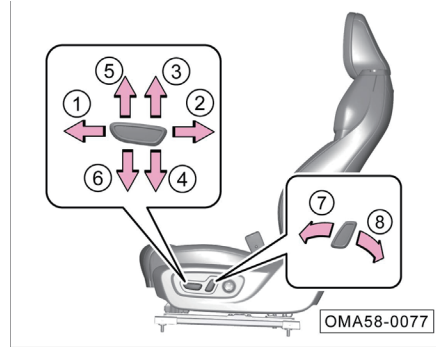

Forward and backward adjustment of seat:

- Push the switch in the direction of -arrow ①- or -arrow ②- to adjust the seat to slide forward or backward.

Upward and downward adjustment of seat (for only driver's seat):

- Pull the switch in the direction of arrow ③ or ④ to adjust the seat upward or downward.

Forward and backward adjustment of seat back:

- Turn the switch in the direction of -arrow ⑤- or -arrow ⑥- to adjust the seat back forward or backward.

#### Manual seat \*

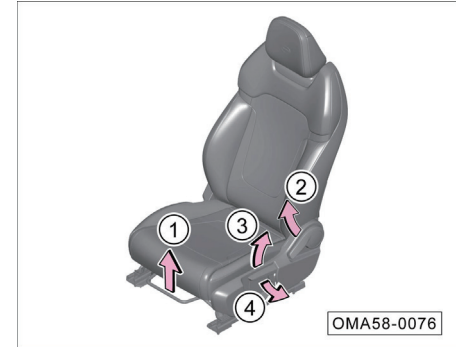

Forward and backward adjustment of seat:

- Pull the adjusting handle in the direction of arrow ① to adjust the seat forward or backward. Then release the adjusting handle, and slide the seat forward or backward slightly until the seat is firmly locked.

Forward and backward adjustment of seat back:

- Pull up the adjusting handle in the direction of arrow ② to adjust the seat back to a desired position, and then release the handle.

Upward and downward adjustment of seat (for only driver's seat):

- Pull the switch in the direction of arrow ③ or ④ to adjust the seat upward or downward.

## 4. Operation of systems and equipment

### Seat ventilation\*

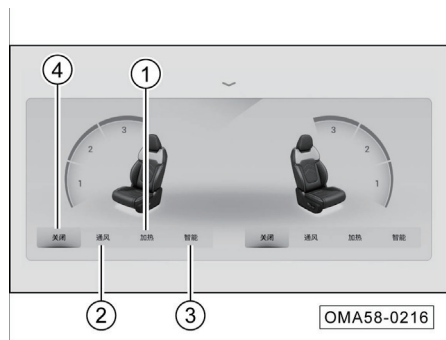

Set the ENGINE START/STOP button to "ON" position, and click the AV system tool bar , so that the seat ventilation setting interface will pop up.

#### ① Ventilation

- When you click "Ventilation", the seat ventilator will work in the 3rd ventilation level by default, and you can click the key 1/2/3 to adjust the heater to the desired ventilation level.
- The seat ventilator has three ventilation positions, among which the 3rd position has the highest fan speed followed by the 2nd position, and the 1st position has the lowest fan speed.

#### ② Intelligence

- Click "Intelligence" to turn on the intelligence mode of seat ventilation.

#### ③ Off

- Click "Off" to turn off the seat ventilation function.

### CAUTION

- Do not kneel on the seat or apply pressure to a point on the seat cushion or seat back, so as to avoid damaging the electrical components in the seat.
- If it is found that the seat fan does not work after the seat ventilation function is turned on, immediately turn off the seat ventilation function and go to the GAC Motor authorized shop for inspection and repair in time.

### 4.4.3 Rear seat

#### Rear seat back folding down / reset

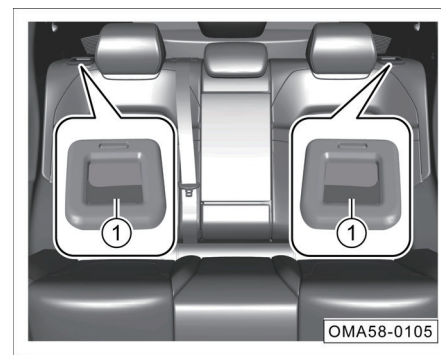

Folding down:

- Pull the seat back switch ① towards the front of the vehicle and turn the seat back forward to recline the seat back.

Reset:

- Push the rear seat back directly backward until the seat back is locked.

### **i** NOTE

Pull the seat back switch ① towards the front of the vehicle and push the seat back backward at the same time until the seat back is locked, and the rear seat back can be adjusted to a certain angle.

### 4.4.4 Storage facilities

#### Storage compartment on door interior trim panel



- Place beverage bottles, map manuals and other articles here.

#### Instrument panel storage compartment

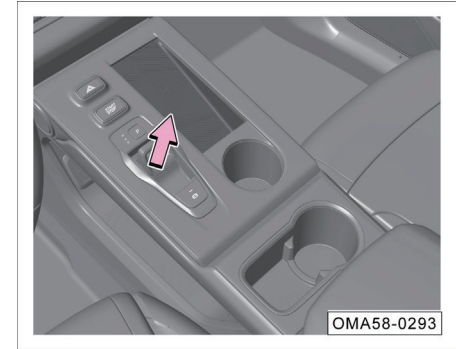

- Place small articles here.

## 4. Operation of systems and equipment

Cup holder

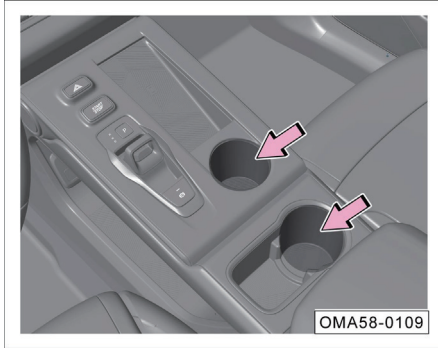

- Front cup holder: beverage bottles can be placed.

Instrument panel lower storage compartment

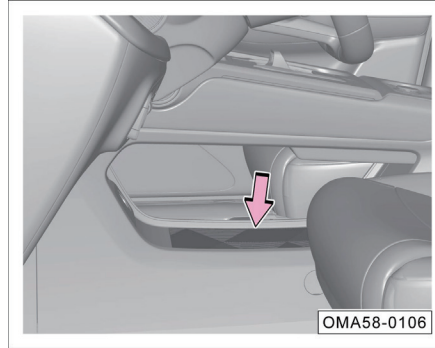

- Place books, ipad, etc. here.

Front central armrest box

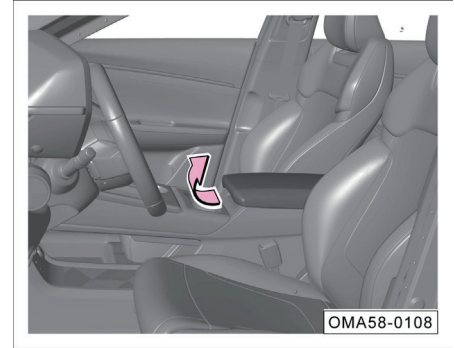

- Open the front seat central armrest box cover upward to place items such as wallets.

## 4. Operation of systems and equipment

### Storage bag on the back of front seat

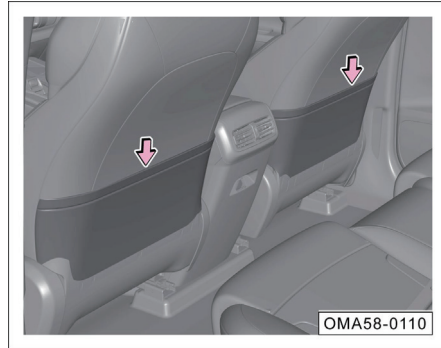

- Pull backward and open the storage bag to place books, foldable umbrellas and other articles.

### Front passenger's glove box

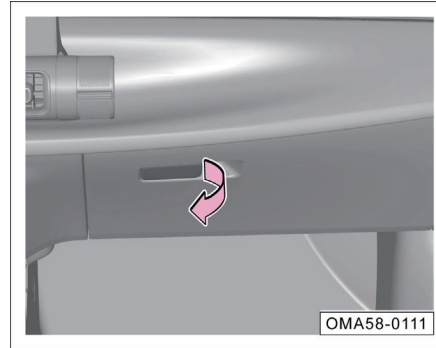

- Pull the handle to open the glove box to place items such as document bags.
- Push back to close the glove box until you hear a "click" sound.

### **i** NOTE

For vehicle models equipped with glove box dampers\*, pull the handle and the glove box will lower automatically and slowly.

### **⚠** WARNING

The glove box must be closed when the vehicle is traveling, otherwise the articles in the glove box may fly out and cause personal injury to the occupants in case of an emergency braking or an accident.

### Central armrest box rear storage box \*

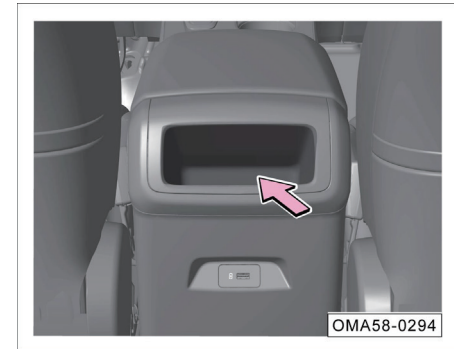

- Place small articles here.

## 4. Operation of systems and equipment

---

### 4.4.5 Low battery reminder

#### Function description:

The vehicle continuously monitors the battery status. When it is detected that the battery level is low, the vehicle has a risk of power loss. The user will be reminded to start the engine to charge the battery through AV system and instrument cluster, thereby improving the starting performance of the vehicle and prolonging the service life of the battery.

#### **i** NOTE

- The low battery reminder function only reminds the state of low battery level, which does not mean that the battery is damaged.
- Low battery reminder cannot avoid battery feeding, so it is still necessary to start the vehicle in time and charge the battery.
- The use of incompatible battery, or irregular disassembly and modification of vehicle electrical equipment may cause the low battery reminder function to be mistakenly triggered or not triggered.

#### Information to be know:

When the engine is not started, because the battery cannot be charged, the use of vehicle electrical equipment (such as radio, lights, etc.) will directly consume battery power, and the battery level will be rapidly reduced. If vehicle electrical equipment needs to be used for a long time, start the engine at the same time.

For short-distance driving, it is recommended that you keep the engine started and continue for a period of time due to the short charging time of the battery.

If your vehicle is parked for a long time, start the vehicle engine regularly and continue for a period of time to charge the battery.

### 4.4.6 Quiescent current management function

#### Function description:

Continuously monitor the power consumption of the electrical equipment and battery level during the parking of the vehicle. When it is detected that the battery level is low, gradually turn off unnecessary electrical equipment to reduce the power consumption of the vehicle electrical equipment, avoid the large discharge of the battery, and prolong the parking time of the vehicle. After the vehicle is started, the power supply of the electrical equipment will be restored immediately.

#### Information to be know:

During the vehicle parking period, some comfort entertainment functions will be affected when the battery level is low. After the vehicle is activated, some comfort entertainment functions will return to normal.



## 4. Operation of systems and equipment

### 4.4.7 Power outlet / USB interface

#### Central armrest box rear USB interface



- With the ENGINE START/STOP button in the “ACC” or “ON” position, a device to be charged can be connected directly for charging.

#### **i** NOTE

The rear USB interface is only used for charging.

#### Front USB interface

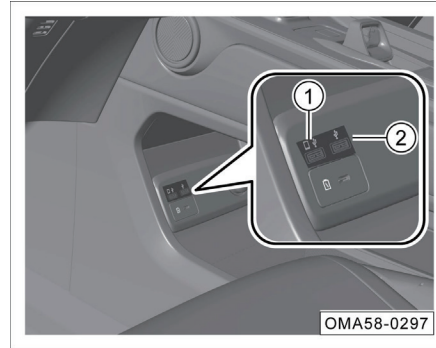

- With the ENGINE START/STOP button in the “ACC” or “ON” position, a mobile device can be connected directly for use.

#### **i** NOTE

USB1 interface ① supports charging, media playback and OTG (mobile phone interconnection) functions.

#### Front TYPE-C interface

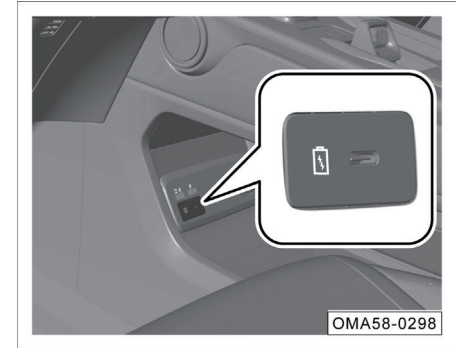

- With the ENGINE START/STOP button in the “ACC” or “ON” position, a mobile device can be connected directly for use.

#### **i** NOTE

The TYPE-C interface is only used for charging.

## 4. Operation of systems and equipment

### Front 12 V power outlet socket



- When the ENGINE START/STOP button is in the "ACC" or "ON" position, after the power outlet cover is opened, a device to be charged can be connected.

#### **i** NOTE

Devices up to 12V/120W are supported.

### 4.4.8 Trunk

In order to ensure the maneuvering stability of the whole vehicle, the luggage shall be placed as evenly as possible, and the heavy objects shall be placed at the front of the trunk.

#### **⚠** WARNING

- **The center of gravity of the vehicle carrying heavy objects may change. If heavy objects in the trunk suddenly slip, the maneuvering stability of the vehicle will change.**
- **The items in the trunk must be fixed, otherwise the items may fly forward and injure the occupants in the vehicle in case of emergency braking or accident.**
- **Never place fragile, flammable and explosive articles in the trunk!**

### Trunk volume

- Fold down the rear seat back to increase the trunk capacity. => See page 88

#### **👁** CAUTION

When placing liquid items, ensure that the container is sealed and the liquid does not leak. Avoid placing liquids on the seat back folded down to prevent liquid leakage and thus wetting the seat.

## 4. Operation of systems and equipment

### Objects in trunk

#### Trunk carpet

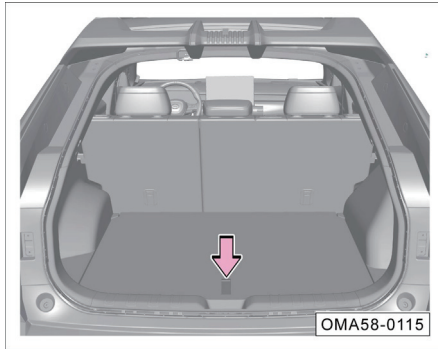

- Pull up the drawstring and open the trunk carpet.

#### Warning triangle

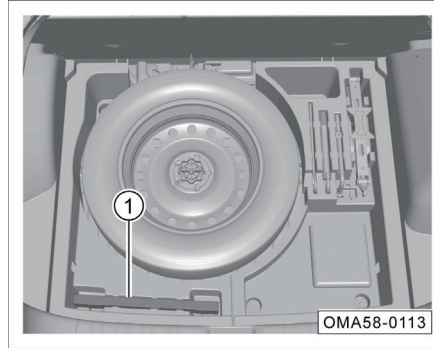

- Pull up the drawstring and open the trunk carpet.
- There is a warning triangle ① in the trunk storage box. Use of warning triangle. => See page 237

#### Driver's tools/spare tire

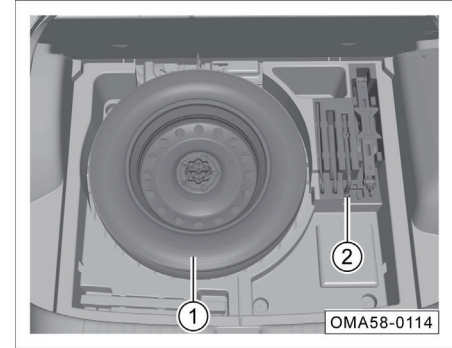

- Pull up the drawstring and open the trunk carpet.
- There are spare tire ① and driver's tools ② in the trunk storage box. => See page 236

## 4. Operation of systems and equipment

### 4.4.9 Luggage rack

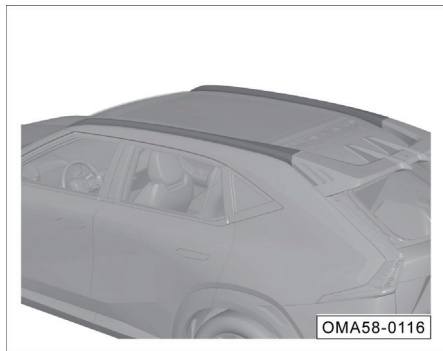

The luggage rack of this vehicle is a decorative part and cannot directly carry articles.

### 4.4.10 Accessories and modifications

Data labels and signs indicating important data and information about the use of the vehicle are affixed to the fuel tank cap, engine hood latch and other components of the delivered vehicle. Do not remove or damage these labels and signs, and always keep the data and information on them legible.

The vehicle is designed with the latest safety technologies by GAC to ensure excellent active safety and passive safety. Therefore, in order to maintain the excellent characteristics of the vehicle, please make sure you consult the GAC Motor authorized shop before installing accessories or replacing parts.

It is recommended to use accessories and parts approved by GAC. Other parts than those GAC genuine parts will not be covered by the warranty.

#### WARNING

**The installation of inappropriate accessories or the modification of the vehicle may affect the maneuvering stability and other performance of the vehicle, and even may cause serious casualties.**

To install a car phone, alarm device, transceiver, low-power AV system, etc., ensure that they will not interfere with the electronic control system such as anti-lock braking system (ABS) on the vehicle.

## 4. Operation of systems and equipment

Before installing the accessories, please ensure that:

1. The accessories neither dim the lamps, nor affect the normal operation or performance of the vehicle.
2. On vehicles equipped with side curtain airbag\*, do not install accessories on the B pillar or across the rear door window. Because installing accessories in these areas will prevent the normal operation of the side curtain airbag\*.

### NOTE

When additions (such as headrest, seat cover, floor mat, sun protection mat, etc.) are required, inferior additions may contain VOCs that do not meet national standards, and may emit unusual odors, causing hidden dangers that affect the air quality in the vehicle; therefore, the genuine high-quality additions are recommended to ensure a comfortable driving environment.

### Modification of vehicle

Dismantling the parts from the vehicle or replacing the genuine parts with non-GAC Motor parts will seriously damage the maneuvering stability and reliability of the vehicle. For example:

- The installation of larger or smaller wheel or tire will interfere with the normal operation of vehicle anti-lock brake system (ABS) and other systems.
- The modification of the steering wheel and other safety devices may cause the system failure.

### WARNING

- **Improper modification of the vehicle or installation of inappropriate accessories may easily cause failures and accidents. The accessories and parts approved by GAC are always recommended, because the adaptability, reliability and safety of these accessories and parts have been strictly verified by GAC.**

### WARNING

- **Improper modification or maintenance of the vehicle may weaken the protective effect of the airbag, which results in system failure and causes fatal accidents. Improper modification of the vehicle or installation of inappropriate accessories may easily cause failures and accidents.**
- **Improper operations or modifications of the vehicle (modification of the engine, brake system or components that affect the performance of wheels and tire) will affect the function of the airbag system and cause serious casualties.**
- **Do not install wheels and tires that are not approved by GAC.**
- **The modifications of the front and the engine compartment of the vehicle may weaken the function of the pedestrian detection system and violate road traffic regulations.**

## 4. Operation of systems and equipment

### 4.5 HVAC system

#### 4.5.1 General description

The A/C filter can filter pollen and dust entering the air inlet of HVAC system.

The A/C filter must be regularly cleaned and replaced according to "Regular Maintenance Schedule" in Warranty Manual.

If the vehicle often runs in areas with poor air quality, the replacement interval of the A/C filter should be shortened. If the airflow from the A/C air outlet is not as smooth as usual, it may be due to the dirty and clogged A/C filter. In this case, clean or replace the A/C filter as soon as possible.



#### WARNING

**If the air in the vehicle is foul, it will make the driver easily fatigued, lack of energy, and distracted, which is easy to cause an accident, resulting in personal injury or even death. Therefore, enable the air circulation mode according to the actual situation.**



#### CAUTION

If the HVAC system fails (such as no cooling, peculiar smell of air, etc.), please go to the GAC Motor authorized shop for inspection and repair.



#### NOTE

- The HVAC system can be operated when the ENGINE START/STOP button is in "ON" position.
- When the A/C is turned on, there will be water dripped under the vehicle. Prolonged parking with the A/C on will cause accumulated water, which is normal.
- Clean the snow, ice and leaves on the front windshield wiper cover regularly to avoid blockage of the air inlet of the A/C and ensure normal air intake of the HVAC system.
- The HVAC system can only play its best role after the windows are closed. However, when the inside temperature is high under hot sun, open the windows briefly to dissipate the inside heat, and then enable the A/C for cooling.

## 4. Operation of systems and equipment

### 4.5.2 A/C system

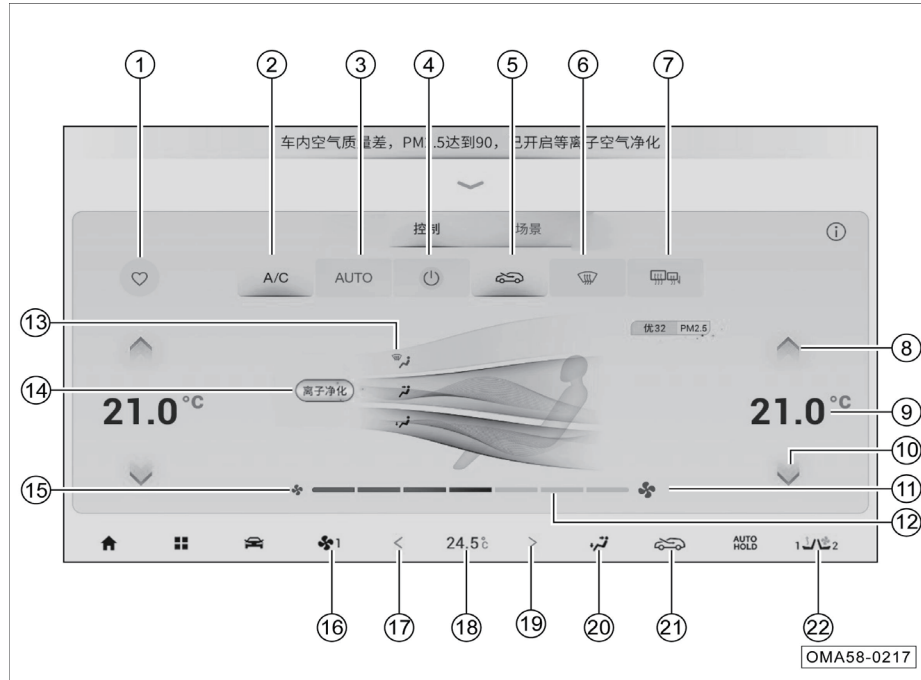

#### A/C control interface description

- ① Seat ventilation soft key \*
- ② A/C cooling button
- ③ AUTO mode soft key \*
- ④ Recirculation/fresh air mode soft key \*
- Recirculation mode soft key
- Fresh air mode soft key
- ⑤ A/C on/off soft keys
- ⑥ Front windshield defrosting and defogging soft key
- ⑦ Rear windshield and exterior rearview mirror defrosting and defogging soft key \*/rear windshield defrosting and defogging soft key \*
- ⑧ Temperature Up soft key
- ⑨ Temperature display
- ⑩ Temperature Down soft key
- ⑪ Air volume Up soft key

OMA58-0217

## 4. Operation of systems and equipment

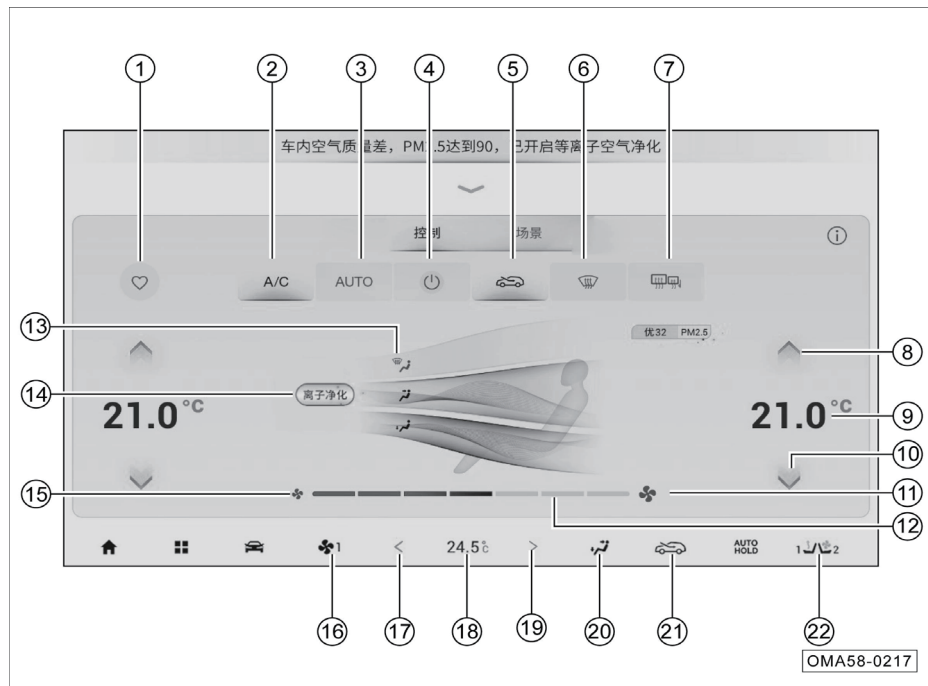

### A/C control interface description (continued)

- ⑫ Air volume level display
  - Display the air volume (7 levels), swipe the button left and right to adjust the air volume.
- ⑬ Air supply mode soft key
- ⑭ Plasma purification function soft key \*
- ⑮ Air volume Down soft key



### A/C control buttons

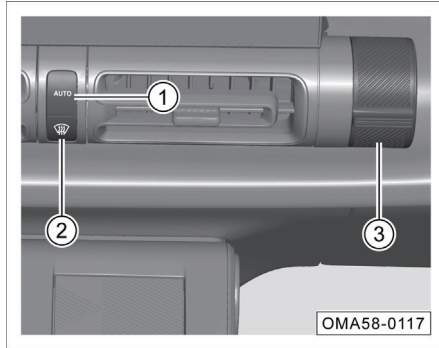

- ① AUTO button / A/C switch button (applicable to models with automatic A/C)
- ON/OFF A/C switch button (applicable to models with manual A/C)
- ② Front windshield defrosting/defogging button
- ③ Temperature adjustment knob

### Temperature control button

- Set the interior temperature by clicking the AV system soft key  $\wedge$  or  $\vee$  soft key. Press and hold the soft key  $\wedge$  or  $\vee$  soft key (for more than 0.5 s), so that the temperature starts scrolling, and release it to end scrolling.
- The temperature can be adjusted by toggling the temperature adjustment knob up and down on the right side of the instrument panel.
- The set temperature can be adjusted within 18.5~31.5 °C, in increments of 0.5°C. When the set temperature is lower than 18.5 °C, the temperature will be displayed as LO, and when it is higher than 31.5 °C, the temperature will be displayed as HI.

In auto mode, when LO/HI is displayed, the system will keep high air volume.

In automatic mode, in order to obtain the most ideal interior temperature, it is recommended to set the temperature to 25.0 °C, and the temperature can be adjusted if necessary.

### CAUTION

The temperature value displayed on the AV system display is the target value of temperature setting, not the actual measured value of the indoor temperature.

### A/C button

Click the A/C soft key of the AV system to turn on/off the A/C compressor.



When the temperature outside the vehicle is lower than 0 °C, if the A/C cooling (dehumidification) function is activated, the indicator lamp will be lit, but the compressor may not work.

When the A/C switch is highlighted, it means that the compressor needs to be turned on (the compressor may not be turned on).

When the A/C switch is not highlighted, it means that there is no need to turn on the compressor (the compressor must be turned off).

## 4. Operation of systems and equipment

### Air volume setting











1. Click  or  soft key to increase/decrease the air volume by one level. The AV system will display the corresponding air volume level.
2. The air volume level can be adjusted by soft key "+" and "-" on the left side of the AV system display.

In automatic mode, the HVAC system will automatically control the air volume, and operating the air volume adjustment soft key will change the system state from AUTO mode to manual mode.



### Turning off of A/C



Click  the AV system softkey, press the AUTO button of the front A/C control panel\*, and the ON/OFF button\* to turn off the HVAC system.

After the HVAC system is off:

- Click  the AV system soft key,  soft key, \*/\* soft key with the HVAC system off.
- Click  AV system soft key,  soft key,  soft key, A/C soft key, (air volume Up)  soft key,  soft key, AUTO soft key \*, plasma purification soft key \*; Press the AUTO button of the front A/C control panel\*, ON/OFF button \* and  button to turn on the HVAC system.

### Air circulation

Repeatedly click the AV system  /  /  \*soft key to switch the air circulation between recirculation mode, fresh air mode and automatic recirculation/fresh air mode\*.

-  Recirculation mode: The air circulation enters the recirculation mode
-  Fresh air mode: The air circulation enters the fresh air mode
-  Automatic recirculation/fresh air mode \*: including automatic recirculation mode and automatic fresh air mode. This function automatically controls the air intake mode of the A/C according to the ambient temperature and outside air quality (applicable to models equipped with AQS). When the quality of outside air is poor, the recirculation mode will be set; when the quality of outside air is good, the fresh air mode will be set according to the ambient temperature.

### CAUTION



- Long-term recirculation mode will cause accumulation of carbon dioxide in the vehicle, which is not conducive to keeping driver clearheaded.
- The recirculation mode in cold or rainy days can easily cause the windows to mist up, affecting the driver's visibility and probably causing serious accidents.

## 4. Operation of systems and equipment



### Automatic mode \*

The button indicator lamp will come on and the A/C system will enter the auto running mode if the “AUTO” soft key on the HVAC system A/C interface and the “AUTO” button on the front A/C panel are pressed. The following functions will be automatically controlled according to the set temperature:

- Outlet air temperature
- Outlet air volume
- Air supply mode
- Air circulation mode
- Working state of the A/C cooling function
- Operating status of the plasma purifier

Click  the soft key  or  soft key to exit the HVAC system automatic mode.

### Front windshield defrosting and defogging

Press the front A/C control panel button  or click AV system  soft key. The button indicator lamp lights up, and the front windshield defrosting and defogging function are turned on.



Press the button  again to turn off the button indicator lamp, turn off the front windshield defrosting and defogging function, and return to the state before defrosting; Or press the AUTO button to enter the automatic mode to turn off the front windshield defrosting and



defogging function.

### CAUTION

- When the temperature is set to the lowest, the defrost/defog function will cause the outer surface of the windshield to mist up, affecting the driver's visibility and probably causing serious accidents. When using the defrost function, it is recommended to set the temperature to a hot or warm position.
- When using the defrost/defog function, if you manually turn off the A/C cooling function, it will cause the front windshield to mist up, affecting the driver's visibility and probably causing serious accidents.
- As for the defrost and defog functions, for quick defrosting and defogging, the air volume is set to level 5 or above by default, and the noise at the air outlet is relatively large. If you want to reduce the noise, you can manually reduce the air volume on the premise of ensuring the driver's sight.

### Rear windshield defrost/defog function

Click the AV system \*/\* button to activate the rear windshield defrosting, defogging function, electrically heating rear windshield and exterior rearview mirror\*.

Press the \*/\* button again to deactivate the rear windshield defrosting and defogging function. If you do not manually turn off the rear windshield defrost/defog function, this function will be automatically deactivated after 15 minutes.



### NOTE

- With the engine shut down, using the rear windshield defrost function for a long time will cause low battery voltage, making it impossible to start the engine.
- The rear defrosting function will be limited to ensure the starting performance under low battery conditions.



## 4. Operation of systems and equipment



### Air supply mode

Click the air supply mode button on the A/C control interface of the AV system or in the resident toolbar at the bottom of the AV display to adjust the front air supply mode.

Switch the AV system to the HVAC system control interface, click  the soft key to switch the air supply mode manually; in the AUTO mode, the HVAC system will automatically control the air supply mode, and when  the soft key is pressed, the system will exit the AUTO mode.

When manually selecting through the front A/C control interface, click  the soft key to switch cyclically according to the following air supply modes:

-  Panel mode: Air flows out from the panel outlets.
-  Panel/floor mode: Air flows out from the panel and floor outlets.
-  Floor mode: Air flows out from the floor outlets.

-  Floor/defrost mode: Air flows out from the front windshield defrost outlets and floor outlets.
-  Defrost mode: Air flows out from the front windshield defrost outlets.

### i NOTE

- The panel/floor  mode is mainly used when the outside temperature is slightly lower in spring and autumn. Therefore, the temperature of the upper outlets is slightly lower than that of the lower outlets, which is a normal phenomenon.
- The air supply mode, set temperature, etc. can be adjusted for personal comfort.
- To ensure that the HVAC system can effectively and automatically control all air supply modes, please keep all air outlets open.
- During cold start in winter, in the auto mode, the A/C system will start from the defrost mode and enable a gradual transition to other modes.

### Negative ion air purifier\*

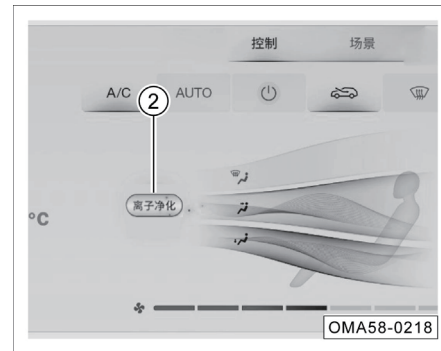

Switch the AV system to the HVAC system control interface, and click the plasma purification soft key , so that the HVAC system turns on the plasma purifier. It can produce negative ions, which can effectively decompose harmful gases such as formaldehyde and benzene in the car, purifying the air in the car.

Click plasma purification soft key  again, so that the HVAC system will turn off the negative ion air purifier.

## 4. Operation of systems and equipment

### 4.5.3 A/C air outlet

#### Instrument panel side air outlet

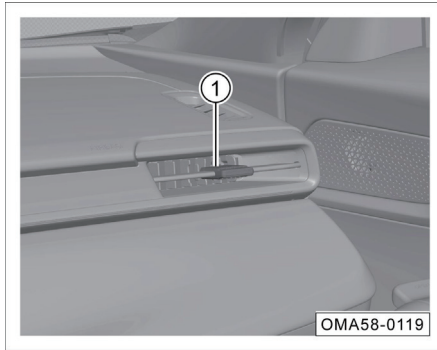

- Toggle the paddle ① to adjust the wind direction or close the air outlet.

#### Instrument panel central air outlet

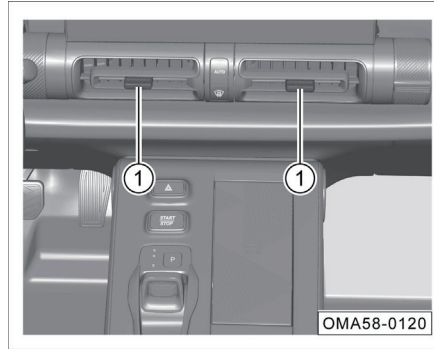

- Toggle the paddle ① to adjust the wind direction or close the air outlet.

#### Rear air outlet\*

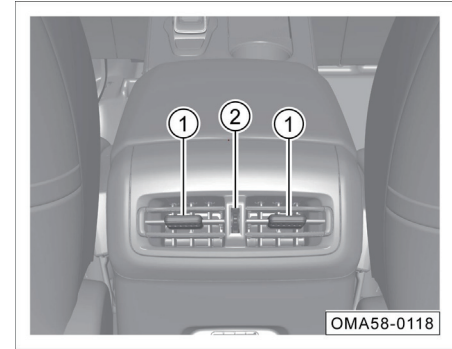

- Toggle the paddle ① to adjust the air direction.
- Rotate paddle ② to adjust the air volume, or close the air outlet.

## 4. Operation of systems and equipment

### 4.6 AV system

#### 4.6.1 Buttons on the right of the steering wheel\*

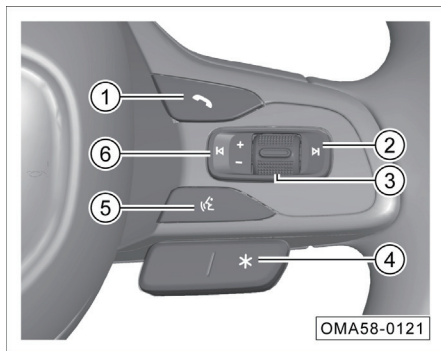

①  Answer/Hang up button

- When there is an incoming call via the Bluetooth, you can give a short press on this button to answer the call.
- When there is an incoming call via the Bluetooth, you can give a long press on this button to hang up.
- When there is no incoming call via the Bluetooth, you can press this button to enter the Bluetooth Dialing interface.
- When the Bluetooth device is not connected, press this button to enter the

Bluetooth setting interface.

②  Next song/channel button

- In radio mode, press this button to automatically search for a valid station with higher frequency. If a valid station is found, the automatic search will be stopped and the station will start playing.
- In media source playing mode, press this button to skip to the next track.

③ Audio source switching button/volume adjustment button/mute button

- Press this button repeatedly to switch as follows: FM → AM → USB1 → USB2 \* → Bluetooth music → online music \* → FM.
- Press and hold this button to mute the media source, and then press and hold this button again to unmute it after muting.
- Toggle up/down this button to adjust the sound volume.

④ Voice button

- With the mobile phone connected to the AV system and the CarPlay/EasyConnection function activated, press and hold this button to activate the CarPlay/EasyConnection voice, and press and hold it again to end the voice.

⑤  Previous song/channel switching button



- In radio mode, press this button to automatically search for a valid station with lower frequency. If a valid station is found, the automatic search will be stopped and the station will start playing.
- In media source playing mode, press this button to skip to the previous track.

## 4. Operation of systems and equipment

### 4.6.2 Basic operations



- ① Smart card area
  - Click the cards to quickly enter the corresponding function interfaces.
- ② Drop-down menu bar
  - Pull down to enter the drop-down menu bar control interface.
- ③ Smart scene area

The smart scene area includes car model, A/C scene (rapid cooling, rapid heating) and driving mode switching, Wallpaper switching.
- ④ System status bar
  - This area indicates “Time”, “Bluetooth Connection”, etc. Click an icon to enter the corresponding function interface.
- ⑤ Bottom toolbar
  - Home button : click it to return to the main interface.
  - System menu button : Click it to enter the application menu interface.

## 4. Operation of systems and equipment

- Driving control panel button : Click to enter the driving control panel.
- A/C information display/control bar area: display the current A/C information, click the A/C area to enter the A/C setting interface.

### ⑥ Application menu interface

- Click the menu button  on the desktop bottom toolbar to enter the system detailed application menu interface.

### Time setting

- Set the time through “Settings → System settings → Basic Settings → Time and Date”.

### Drop-down menu bar

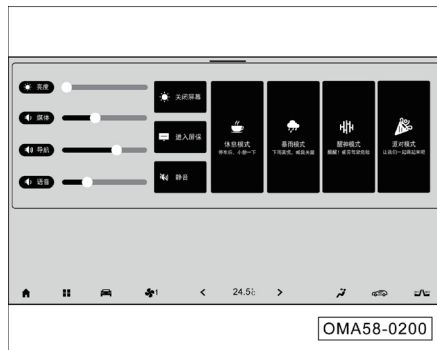

Slide down from the top of the screen (drop-down area) to call out the drop-down menu. Click on  or swipe up to hide the drop-down menu bar. In the drop-down menu bar interface, if there is no operation, the drop-down menu will be automatically hid after a period of time.

Click the drop-down menu bar function button to turn on/off the corresponding function, or enter the corresponding function interface.

### My car



After the AV system works normally, click on car model in smart scene in the main interface or the “My Car” soft key in the application menu interface to enter the My Car interface.

“Opening/closing control (sunshade \*, window\*)”, “cabin (seat ventilation \*, rearview mirror adjustment)”, “lighting effect \* “ can be adjusted.



### CarPlay

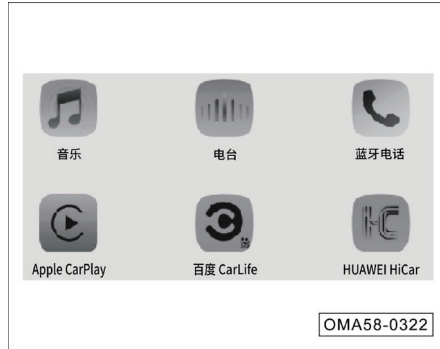

The CarPlay allows you to use navigation, make calls, send and receive messages, and enjoy music while focusing on driving.

#### Method 1:

- Use a USB cable to connect the phone and the USB port of the main unit. After successful connection, the system will automatically switch to the CarPlay main interface, and the Apple CarPlay icon in the system interface will be highlighted.

#### Method 2:

- Turn on the Bluetooth of the mobile phone and search the mobile phone in the Bluetooth connection interface of the IHU. Click the mobile phone and select CarPlay in the choice box after successful connection,

#### Operation to return to the IHU system

- Click "GAC" icon in the CarPlay application menu interface to return to the IHU system.
- Click the "CarPlay" icon in the AV system application menu interface to enter the CarPlay mobile connection.

### i NOTE

- For the functions and applications supported by CarPlay, refer to the Apple's official website. According to the information released by Apple in 2019, Apple CarPlay supports iPhone5 and above.
- When using CarPlay, make sure that the CarPlay function is enabled via "Settings → General → Access Restriction" on the iPhone, otherwise the iPhone will only be used as an iPod and the Apple CarPlay will not be available.
- Please use the genuine iPhone data cable, otherwise connection failure may occur.

## 4. Operation of systems and equipment

---

### EasyConnection



EasyConnection allows you to use navigation, phone call, music and mobile phone projection screen function without distracting you from driving. If EasyConnection is not installed on your mobile phone, download the APP by searching it in the APP store or scanning the QR code on the IHU.

#### Method 1:

- Android mobile phones that support EasyConnection can be connected to the USB interface of the host. Click the EasyConnection icon on the IHU to enter the function and connect the mobile phone automatically.

#### Method 2:

- Click EasyConnection icon to enter the connection interface. Use the mobile phone to scan the QR code for wireless connection.

#### Operation to return to the IHU system

- Click the icon  on the Easy Connection system interface to return to the IHU system.
- Click the “EasyConnection” icon in the AV system application menu interface to enter the EasyConnection again.

### 4.6.3 Radio

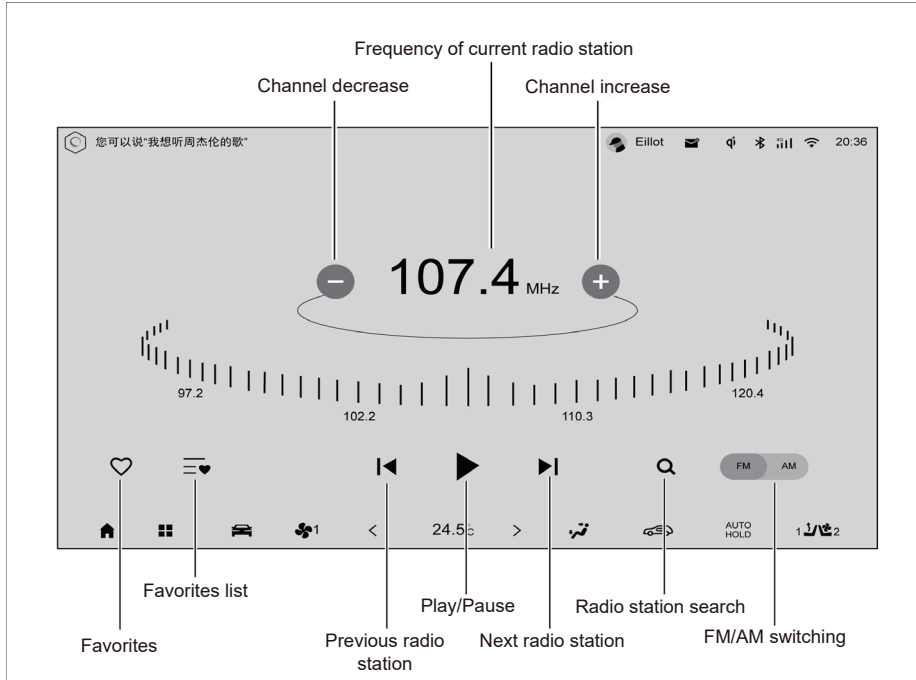

Enter the radio interface in the following ways:

- Enter the radio interface by clicking on the "Radio" card in the main interface.
- Press the sound source switching button on the right side of the steering wheel repeatedly to switch to the Radio interface.
- Click the "Radio Station" soft key in the application menu interface to enter the radio interface.

## 4. Operation of systems and equipment

### 4.6.4 Local music

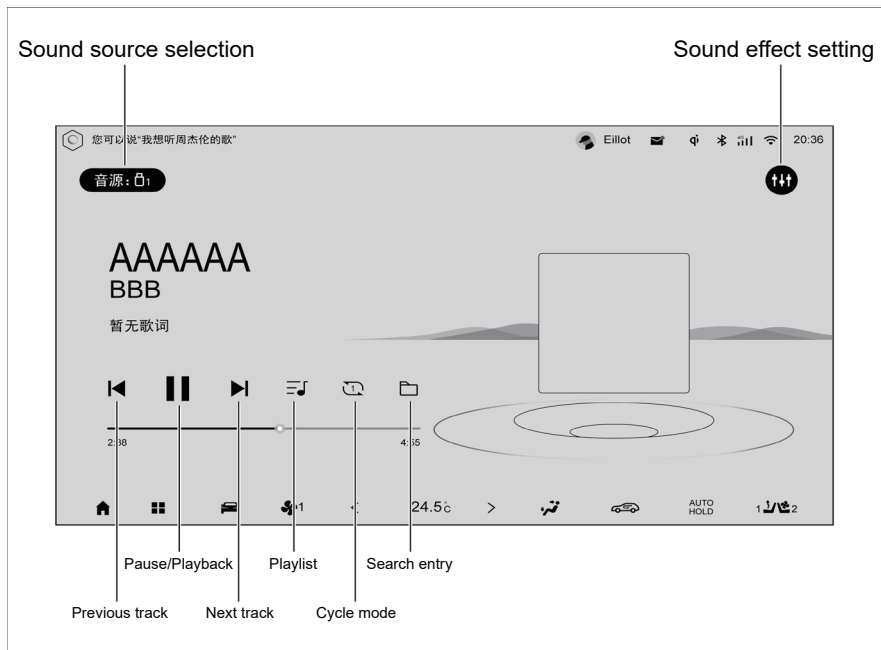

Enter the local music playback interface in the following ways:



- Enter the local music interface by clicking on the “Meida” card in the main interface.
- Press the sound source switching button on the right side of the steering wheel repeatedly to switch to the local music interface.
- Click the “Local Music” soft key in the application menu interface to enter the local music interface.

#### **i** NOTE

The AV system only supports USB devices in FAT16/32, exFAT and NTFS formats, and supports lossless music.

### 4.6.5 Bluetooth function

Enter the Bluetooth mode in the following ways:

- Click the “Phone” soft key in the application menu interface to enter the Bluetooth mode.
- Click on the “Bluetooth call” card in the main interface in the card mode to enter the Bluetooth mode.
- Click  the status bar icon in the upper right corner of the AV system interface to enter the Bluetooth mode.
- Press the button  on the right side of the steering wheel to enter the Bluetooth mode.



- If there is no Bluetooth device connected, enter the Bluetooth connection interface in the above way.
- Click the “Bluetooth switch” soft key  to turn on the Bluetooth function, and the IHU will automatically search for nearby Bluetooth devices. The Bluetooth connection interface has two display modes “radar” and “list”.

#### Radar display mode



- Bluetooth device: The names of nearby Bluetooth devices that can be connected will be displayed, and select the device to be connected and click to connect it.
- Switch to list display mode: Click  the soft key to switch to the list mode, the number displayed in the list mode is the number of Bluetooth devices that can be connected around.

#### List display mode

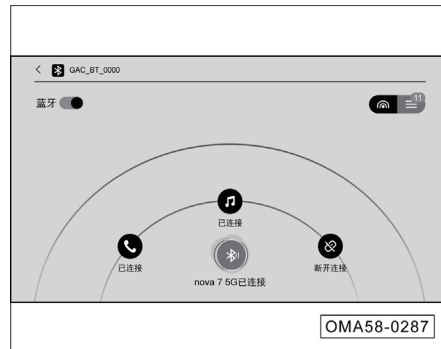
- Bluetooth device: Bluetooth devices that can be connected around will be displayed in a list.
- Switch to radar display mode: Click  the soft key to switch to the radar display mode, the number of Bluetooth devices that can be connected around will be displayed.



After the Bluetooth connection, the status bar icon will be highlighted, and the connected Bluetooth device name will be displayed on the Bluetooth connection interface:

- Click the  soft key to synchronize mobile phone number, address book and other information.
- Click the  soft key to synchronize the song name information of Bluetooth music.
- Click the  soft key again to disconnect the Bluetooth.

## 4. Operation of systems and equipment

### 4.6.6 Child seat with smart Bluetooth\*

#### Connect Bluetooth seat

Fasten the Bluetooth seat belt, turn on the Bluetooth switch in the Bluetooth setting interface, and check the available Bluetooth devices. The Bluetooth device “Welldon\_XXXXX” is displayed.

- Click on the Bluetooth device “Welldon\_XXXXX” to connect it. After the connection is successful, “Connected” will be displayed.
- Click “Disconnect” to disconnect the Bluetooth child seat.
- Click “Ignore the device”, so the confirmation window for ignoring the Bluetooth device pops up. Click “Cancel” to keep the Bluetooth device connected. Click “Confirm” to disconnect the Bluetooth device, so the Bluetooth device “Welldon\_XXXXX” is removed from the list.

When the child leaves the seat for a period of time, Bluetooth will go to sleep. Wake up Bluetooth again as follows:

- Trigger the seat cushion switch manually.
- Restart the device.

#### **i** NOTE

- The communication function of the smart Bluetooth child seat is only suitable for Welldon Zhixuan - customized model for GAC.
- When the Bluetooth device “Welldon\_XXXXX” is connected successfully for the first time, the system will connect automatically the next time it needs to be used.

#### Bluetooth seat alarm

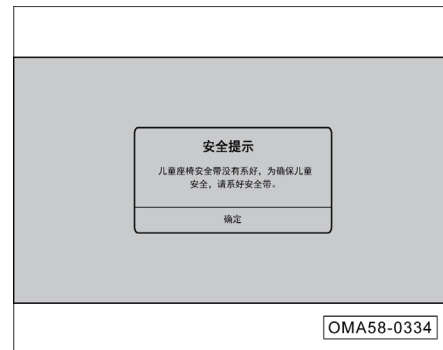

During the normal use of the Bluetooth seat, if the seat belt is loose, an alarm message reading “The child seat belt is not fastened properly. Please fasten the seat belt to ensure the safety of children.” will pop up in the AV system interface and always exists. After the seat belt is fastened, the pop-up alarm window disappears.

## 4. Operation of systems and equipment

### 4.6.7 Settings

Enter the system settings interface by pressing the soft key “Settings” in the application menu. Click on an option to select it, click on the slider  to enable/disable the function, and drag the progress bar for adjustment.

Settings group	Function	Function	Options
Device connection	Bluetooth	Device name	/
		Bluetooth switch	On/Off
		Auto connection	On/Off
		Automatically Sync Contacts	On/Off
		List of paired devices	/
	Apple CarPlay device	Add new device	/
ADiGO intelligent driving	ADiGO active safety assistance	FCW*	On/Off (far/medium/near)
		AEB*	On/Off
		LKA*	ON/OFF (Steering/WARNING/Steering and WARNING)
		TSR *	On/Off
		ISLACC*	On/Off
		Display of longitudinal distance from vehicle ahead*	On/Off
		Intelligent avoidance *	On/Off
Chassis and powertrain	Chassis and powertrain	Current driving mode memory	On/Off

## 4. Operation of systems and equipment

Settings group	Function	Function	Options
Body accessories	Exterior light	Intelligent high beam*	On/Off
		Follow Me Home	On/Off
	Door/window lock	Remote unlocking	All doors/driver's door only
		Auto unlock when the engine is shut down	On/Off
		Intelligent active locking	On/Off
		Intelligent active unlocking	On/Off
		Vehicle speed lock	On/Off
		Easy open of liftgate*	Off/On without honk/On with honk
		Locking-sensitive window closing*	On/Off
	Electric flush-fit door handle	On/Off	
	Exterior rearview mirror*	Automatic folding of exterior rearview mirror	On/Off
	A/C	Automatic air volume *	Low air volume*/Medium air volume*/High air volume
		Intelligent control of recirculation/fresh air mode*	On/Off
Other Accessories	Automatic wiper *	On/Off	
	Wiper maintenance mode	Wiper maintenance mode	
Screen display	Center console	Center console display brightness	/
		A/C interface hold time	5 seconds/10 seconds/15 seconds/30 seconds
		Desktop wall paper	Select new wall paper
	Instrument	Instrument brightness	/



## 4. Operation of systems and equipment

Settings group	Function	Function	Options
Sound effect settings	System sound effect	Media volume	/
		Call volume	/
		DTS sound effect*	On/Off
		DTS sound effect mode* <sup>1)</sup>	Natural soundtrack/clear voice/subbass/leisure mode
		Best listening position*	Driver/All occupants mode
		Equalizer mode <sup>2)</sup>	Classic/Pop/Jazz/Rock/Custom
		Treble *	-10~10
		Alto*	-10~10
		Bass *	-10~10
		Sound field *	Reset
		Speed-sensitive volume control	On/Off
		Startup volume	Unchanged/Adaptive
		Driving assist chime and media sound	Unchanged/Reduced/Mute
	Unlock/lock prompt sound	On/Off	
Interactive sound effect	Touch tone	Off/Modern/Retro	
	Interface sound effect	On/Off	

## 4. Operation of systems and equipment

---

Settings group	Function	Function	Options
System settings	Basis Settings	Time and date	Setting
		24-hour system	On/Off
		Language setting	Chinese/English/Arabic/Indonesian/Spanish
	System Information	System version	/
		Memory size	/
		Factory reset	Reset

Note: 1) It can be selected when “Off” is selected for DTS sound effect setting.  
2) It can be selected when “ON” is selected for DTS sound effect setting.

### 4.7 Emergency rescue

Emergency rescue functions include automatic call after crash, manual emergency call. Automatic call after crash will be automatically enabled by GAC Motor T-BOX under certain circumstances, while manual emergency call need to be manually enabled by pressing the emergency call button. Both automatic call after crash and manual emergency call functions can call emergency contact.

-Automatic call after crash: when the vehicle is involved in an accidental collision and the airbag is deployed, GAC Motor T-BOX will activate the automatic call after crash function to automatically call the set phone number of the emergency contact.

- Manual emergency call: when the automatic call after crash function does not work, you can also manually press the emergency call button to start the manual emergency call function, and then call the phone number of the emergency contact.

Emergency call button

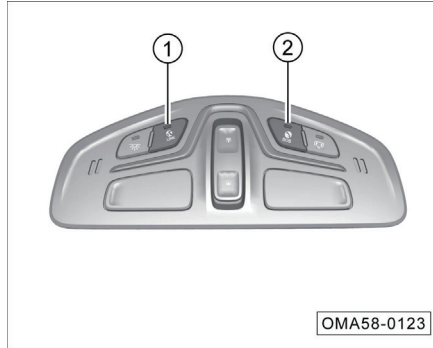

- SOS button ①: press and hold (3s) this button to make the GAC Motor T-BOX to start the manual emergency call function, and call phone number of the emergency contact.

#### **i** NOTE

- Please use the emergency call button only when necessary.
- The contact number of the emergency contact person you designate will be entered with your agreement when you buy this vehicle.

## 5. Driving guide

### 5.1 Starting and driving

#### 5.1.1 Engine start/stop button

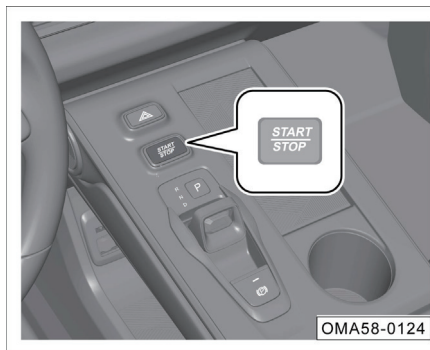

The ENGINE START/STOP button (START STOP button) can only be operated when the intelligent remote control key is detected in the vehicle.

When the transmission gearshift lever is in P gear and the brake pedal is depressed, press the ENGINE START/STOP button to start the engine.

When the transmission gearshift lever is in P gear and the brake pedal is not depressed, press ENGINE START/STOP button to shift gear in the order of "OFF→ACC→ON→OFF".

#### Limphone mode

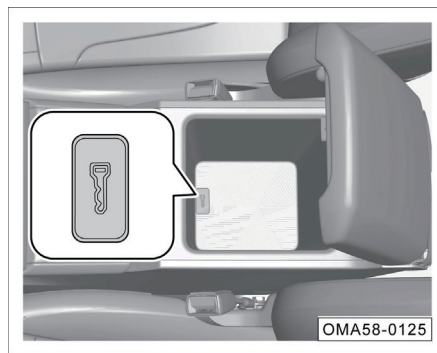

When "No key detected" appears on the instrument cluster display due to low battery of the intelligent remote control key, you can try to place the key horizontally at the mark on the bottom of the front central armrest box, then press the ENGINE START/STOP button to

switch it to "ACC" or "ON" position or depress the brake pedal, and press the ENGINE START/STOP button to start the engine.

This method is intended for emergency start. Please replace the battery of the intelligent remote control key as soon as possible.

### 5.1.2 Engine start

- Enter the vehicle with the intelligent remote control key.
- Make sure the gearshift lever is in "P" or "N" position.
- Step on the brake pedal.
- Press the ENGINE START/STOP button to start the engine.

#### NOTE

In case of a cold start, run the engine at idle speed to warm up it before driving. At the same time, the valve tappet takes a few seconds to reach the normal working pressure and operation noise will occur, which is normal.

#### CAUTION

- The engine start time shall not exceed 15s. If the engine is not started successfully, you must wait about 30s before next attempt.
- Do not depress the accelerator pedal hard to make the engine run at high speed or overload after starting. Otherwise, the engine is likely to be damaged.
- If the battery level is low and the engine cannot be started, try to start it by a jumper cable. => [See page 244](#)
- It is prohibited to start the engine by pushing or towing the vehicle.

#### WARNING

- **Do not keep starting the engine for a long time in a poorly ventilated place or an enclosed place. The engine exhaust contains harmful gases which can make people comatose and even suffocate.**
- **Never let the engine idle unattended.**
- **Do not add a starting aid for starting the engine, as it is likely to make the engine run at high speed or cause an explosion.**

## 5. Driving guide

### 5.1.3 Engine shutdown

- Park the vehicle steadily and apply the parking brake.
- Set the gearshift lever to the “P” gear.
- Release the brake pedal and press the ENGINE START/STOP button to turn off the engine.

#### **i** NOTE

After the engine is shut down, the radiator fan may still be running for a while.

#### Emergency shutdown

When vehicle is running, press and hold the ENGINE START/STOP button or press the ENGINE START/STOP button three times to switch the ENGINE START/STOP button from “ON” gear to “ACC” gear for emergency shutdown of the engine.

The engine can only be restarted in a few seconds after emergency shutdown. Restart the engine as follows:

- After setting the gearshift lever to “P” or “N”, press the ENGINE START/STOP button to start the engine.

#### **⚠** WARNING

**Emergency shutdown is forbidden during normal driving, as it is likely to lead to vehicle damage, safety and power steering failure, and traffic accidents.**

#### Precautions for parking

When parking, set the gearshift lever to “P” or “N” position, and pay attention to the following:

- Pay attention to the direction in which the vehicle is parked, for fear of damage to the green belt with the exhaust gas spraying on the plants.
- Try to park on a flat and straight road, instead of a steep slope.
- When parking on a slope, regardless of whether the vehicle is facing the top or bottom of the slope, the front wheels should be turned towards the curb.
- Apply the parking brake, shut down the engine, and turn off all lights and other electrical consumers.
- Before leaving the vehicle, be sure to carry valuables and the key with you, and check that the windows, doors, and liftgate are closed or locked.

#### **⚠** WARNING

- **When leaving the vehicle, you must turn off the engine, apply the parking brake, and carry the vehicle key with you.**
- **Do not leave any person in the vehicle. Otherwise, suffocation, coma and even death can easily occur in the closed space.**
- **Do not park the vehicle near the flammables or explosives.**

### 5.1.4 Gear description

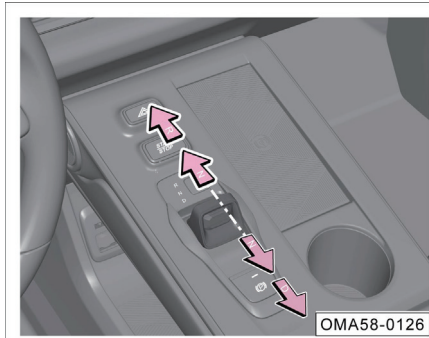

There are “P, R, N, D” positions on the gearshift lever. When the ENGINE START/STOP button is in the “ON” position, and the gearshift lever is set to a position, the instrument cluster will display the corresponding position.

- Push the gearshift lever forward to shift from “D” position from “R” position. In this process, there are two resistance points. The first resistance point indicates “N” position, and the second resistance point indicates “R” position.

- Push the gearshift lever backward to shift from “R” to “D”. In this process, there are two resistance points. The first resistance point indicates “N” position, and the second resistance point indicates “D” position.

#### WARNING

**The “R” or “P” position can be engaged only when the vehicle is completely stationary, otherwise the transmission will be damaged.**

### P: Parking

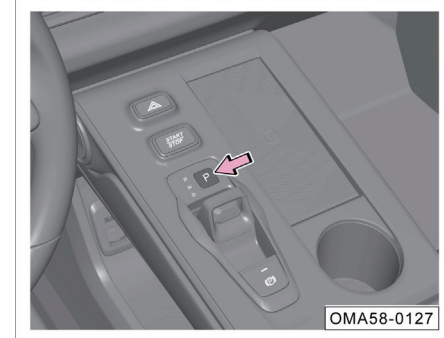

- This position is to be engaged after the vehicle has stopped completely for the purpose of parking.
- For long-time parking, please depress the brake pedal, put the gearshift lever into “N”, pull up the “EPB” button, release the brake pedal, and then press the “P” button.

## 5. Driving guide

---

### NOTE

- Please note that the instrument panel will display the current gear position.
- When the driver's door is ajar, it is impossible to set the gearshift lever to the required gear position.
- When the shift system fails and the "P" position can not be disengaged, please contact the GAC Motor authorized shop for inspection and repair.

### **R: Reverse**

- This position is to be engaged for reversing.
- With the vehicle completely stationary and the transmission in "P" or "N" or "D" position, step on the brake pedal and push the gearshift lever forward to shift to "R" position.

### **N: Neutral**

- This position is to be engaged for temporary parking.
- With the transmission in "P" position, step on the brake pedal and push the gearshift lever forward to the first resistance position to shift to "N" position.
- With the transmission in "D" position, step on the brake pedal and push the gearshift lever forward to the first resistance point position to shift to "N" position.
- With the transmission in "R" position, step on the brake pedal and push the gearshift lever backward to the first resistance point position to shift to "N" position.



### **WARNING**

**Do not make the vehicle coast with the gearshift lever in "N" position. Otherwise, it is likely to cause an accident.**

### **D: Drive**

- This position is to be engaged for normal driving.
- Step on the brake pedal and pull the gearshift lever backward to shift from "P", "N" or "R" position to "D" position.

### **Driving mode**

Driving mode can be switched via AV system:

- ECO: In this mode, the slight power hysteresis occurs and fuel consumption is more economical.
- COMFORT: In this mode, the dynamic response and fuel consumption are more balanced.
- SPORT (sport) mode: In this mode, the dynamic response is rapid and the fuel consumption is high.



### Driving mode selection

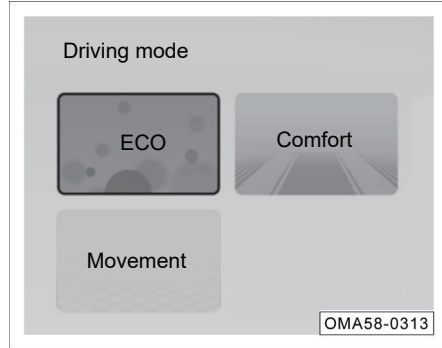

1. Set the ENGINE START/STOP button to the "ON" position, and check the current driving mode or select the corresponding driving mode by the driving control panel key  on the bottom toolbar in the AV system.

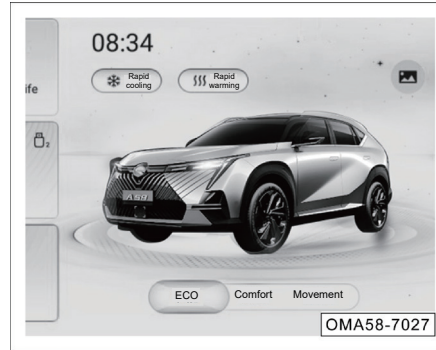

2. Set the ENGINE START/STOP button to the "ON" position, and switch the driving mode through the smart scene of the AV system main interface.

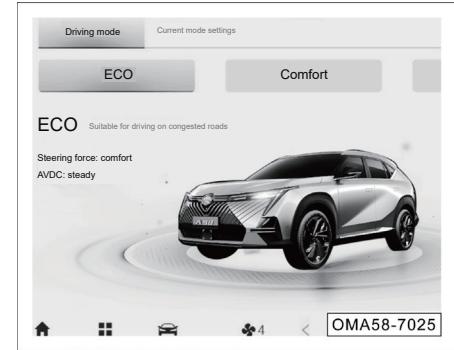

3. Set the ENGINE START/STOP button to the "ON" position, and switch the driving mode by AV system application menu "Adaptive vehicle dynamic control (AVDC) → Driving Mode".

## 5. Driving guide

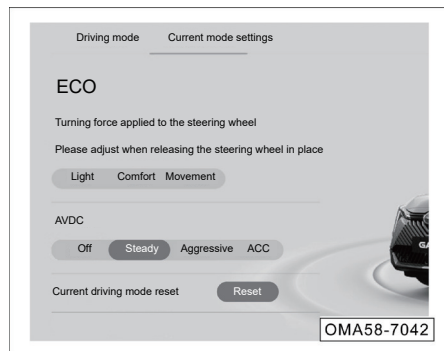

- Set the current driving mode parameters by AV system application menu “Adaptive vehicle dynamic control (AVDC) → current mode settings”.

### i NOTE

- For each driving mode, there is a reset button to restore the factory setting of the mode with one button.
- If you want to memorize the current driving mode, you need to enable the memory through the AV system “Settings → Chassis and Powertrain → Current Driving Mode Memory”, and the current driving mode will be defaulted to the next time you start the vehicle.

## 5.2 Brake system

### 5.2.1 Service brake

Under certain driving and weather conditions, squeaks, screams, or other noises may be heard from brakes when the brake pedal is depressed for the first time or lightly stepped on, or braking noise during light or moderate braking, especially for new vehicles (as their brakes have not undergone running-in), which is normal, and does not constitute a failure symptom of braking system nor has effects on the braking safety and performance.

### 👁 CAUTION

- If there is metal-metal friction rasp, the brake lining may be worn to the limit. Please go to the GAC Motor authorized shop for inspection and repair as soon as possible.
- If the steering wheel vibrates or twitches continuously during braking, go to the GAC Motor authorized shop for inspection and repair as soon as possible.

### **i** NOTE

- Do not rest your foot on the brake pedal during driving, otherwise the brakes will heat up to an abnormally high temperature, and the brake linings and brake discs will wear excessively, increasing the braking distance.
- Continuous application of the brake will cause brake overheat and result in a temporary loss of braking performance.
- Under normal driving conditions, brake linings will wear, and dust will accumulate on wheels, which is inevitable but yet has no effect on the braking performance.
- If rust and corrosion exist because the brake linings and brake discs are not used or used rarely, noise may be heard from brakes for the first use. This is normal. It is recommended that braking be carried out several times in a safe area and under good road conditions to clean the brake linings and discs.

### **Brake booster**

The brake booster is used to increase the pressure applied by the driver on the brake pedal, and it only works when the engine is running.

If the brake booster does not work properly due to a fault, or when the vehicle is towed, the force on the brake pedal must be increased to compensate for the assist power loss of the brake booster.

### **i** WARNING

- **Never make the vehicle coast with the engine shut down, because at this moment, the brake booster does not work, the braking distance will be greatly increased, and an accident is likely to be caused.**
- **If the brake booster does not work (for example, when the vehicle is being towed), please depress the brake pedal with force much greater than that applied under normal condition.**

### **Braking effect and braking distance**

The braking effect and braking distance mainly depend on the driving environment, road conditions and driving style,

Worn brake linings do not provide effective braking. The wear rate of brake linings mainly depends on the vehicle operation conditions and driving style. If the vehicle often runs for urban driving, short-distance driving, or as a racing vehicle, it is recommended that the driver checks the brake lining thickness more frequently based on the maintenance cycle specified in the Warranty Manual.

After wading, heavy rain or vehicle washing, brake linings may get wet or icy (in winter), resulting in a reduction in braking effect. In this case, be sure to depress the brake pedal lightly to heat the brake by friction and evaporate the moisture to restore the braking effect.

## 5. Driving guide

---

### WARNING

A new tire and brake lining having not undergone running-in do not have the best adhesion and friction characteristics.

- The new tires do not have the best adhesion, so you must drive carefully within the first 500 km to prevent accidents!
- New brake linings in the first 200km to 300km driving distance do not get the best friction characteristics, and braking effects are not as good as expected, so new brake linings must be subject to running-in. Braking effects can be compensated by increasing the force applied to the brake pedal. New brake linings must also be subject to running-in.
- During driving, do not get too close to other vehicles or bring the vehicle to a situation where emergency braking is necessary. Take care especially when driving with a new tire and new brake lining having not undergone running-in, for fear of accidents!

### WARNING

When the brake is wet or icy or when the vehicle is running on a salted road, the braking lag may occur, resulting in a longer braking distance. Therefore, be careful to prevent accidents.

- A longer braking distance or a fault in the braking system will increase the accident rate.
- Check the brakes by pressing the brake pedal lightly.
- Lightly depress the brake pedal to dry brakes or remove ice or anti-skid salt from brakes.

### WARNING

Overheating of the brake will reduce the braking effect and lengthen the braking distance!

- Take care to avoid overheating the brake.
- When driving downhill, brakes are likely to be overheated as the brake load increases.
- Do not keep depressing the brake pedal. Otherwise, brakes will overheat and the braking distance will increase. Brake the vehicle intermittently according to road and traffic conditions.

### WARNING

- **The brake fluid must be changed every two years. If the brake fluid stays in the brake system for a long period, air resistance may occur in the pipeline during braking, reducing the braking effect significantly and impairing driving safety, and even causing failure of the brake system, resulting in an accident thereby!**
- **If the front spoiler is out of standard or damaged, it will block the cooling airflow to brakes, causing brakes to overheat and reducing the braking effect.**

### 5.2.2 EPB

The driver can apply or release the parking brake by operating the EPB button. HSA can be applied for driving on a slope. When the accelerator pedal is depressed with the vehicle parked, the EPB will be automatically released to provide driving assist for the driver.

### NOTE

- EPB will choose different application force strategies on different slopes. EPB can realize parking on a slope with a maximum gradient of 30%. If parking on a slope with a gradient greater than 30%, there will be a risk of slipping, and the EPB will be applied again, which is normal.
- If the vehicle continues to slide down after the EPB is applied to park the vehicle on a slope below 30% and then applied again against slipping of the vehicle, please depress the brake pedal and drive the vehicle to a flat road. It is recommended to go to the GAC Motor authorized shop for inspection and repair in time.

### Application of static park brake

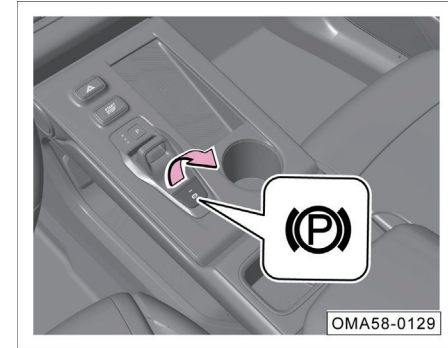

- When the vehicle is stationary, lift the EPB button or press the P gear button in the direction of the arrow. The button indicator lamp and the indicator lamp (P) on the instrument cluster will come on, indicating that the EPB has been applied.
- When the gearshift lever is moved to the "P" position from other positions, the EPB will be applied automatically.

## 5. Driving guide

### **i** NOTE

- The EPB can also be applied when the ENGINE START/STOP button is in the “OFF” position.
- After the vehicle is parked steadily, the EPB should be applied first.
- When EPB is applied, running noise will be generated, which is normal.
- If there is a trailer or the vehicle is parked on a large slope (more than 30%), if the vehicle still slides after the EPB is applied again, please step on the brake pedal to brake and drive the vehicle to a flat road and stop stably.
- After the EPB is applied, it can ensure that the vehicle does not slide on a slope with a gradient of 30% within 5min. If sliding occurs during this duration, the EPB will be applied again.
- Be sure to apply the EPB during parking.

### **⚠** WARNING

**When the vehicle is running, do not apply the EPB for speed reduction unless necessary, as the EPB only applies braking force to rear wheels, which is likely to cause traffic accidents.**

### Release static park brake

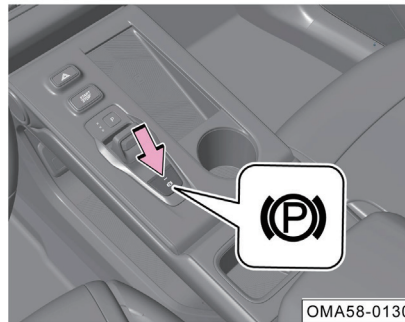

- When the ENGINE START/STOP button is in the “ON” position and the gearshift lever is not in the P position, depress the brake pedal and press the EPB button till the button indicator lamp and the indicator lamp in the instrument cluster (P) go out, indicating that the EPB has been released.

- When the ENGINE START/STOP button is in the “ON” position and the gearshift lever is not in the D or R, close the door, fasten the seat belt, and depress the accelerator pedal to release EPB automatically, till the indicator lamp in the instrument cluster (P) go out, indicating that the EPB has been released.
- When the ENGINE START/STOP button is in the “ON” position, close the door, fasten the seat belt, and shift the gear from P to any other gear to release EPB automatically, till the indicator lamp in the instrument cluster go out, indicating that the EPB has been released.

### **i** NOTE

- If the EPB button is pressed without depressing the brake pedal, the EPB will not be released, and the instrument cluster will display an alarm message accompanied by a buzzer alarm.
- When the EPB is released, running noise will be generated, which is normal.
- When the battery is low, the system cannot release the EPB. If conditions permit, you can connect a jumper cable for emergency start, and then release the EPB. Contact the GAC Motor authorized shop for inspection and repair.
- If the EPB has not been used for a long time, the system will perform automatic test, and operation noise will be heard at this time.
- Press and hold the EPB button and press the ENGINE START/STOP button at the same time to turn off the power of the whole vehicle to realize towing with power "OFF".

### Application of dynamic emergency braking

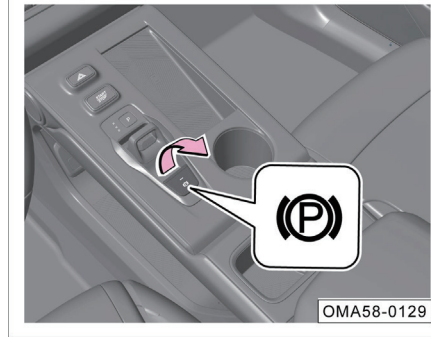

- If the service brake fails during vehicle driving, try to continuously pull up the EPB button, and then release the EPB button or step on the accelerator pedal to exit the emergency braking.

### **i** NOTE

- When the vehicle is running, if the EPB system button is pulled up, the instrument cluster display will give an alarm message, together with a beep alarm.
- When the vehicle is slowing down, release the EPB button or depress the accelerator pedal to release the parking brake again. If the EPB button is continuously pulled up until the vehicle stops, the parking brake will remain engaged.

### **👁** CAUTION

Do not use dynamic emergency braking unless necessary, as it is likely to cause traffic accidents. Moreover, the braking distance is longer than braking by depressing the brake pedal, and the service life of the parking brake system will be shortened.

## 5. Driving guide

### CAUTION

In case of the following phenomena, please operate the EPB again. If the fault still remains, please go to the GAC Motor authorized shop for inspection and repair.

- If the indicator lamp (Ⓢ) continues to flash red, it indicates that the EPB is partially engaged/disengaged or the system is faulty.
- If the indicator lamp (Ⓢ) comes on in red when EPB is not applied, it indicates that the system is abnormal.
- If the indicator lamp (Ⓢ) comes on in yellow, it indicates that a fault is detected in EPB and the EPB is degraded.

### AUTO HOLD

#### On and Off

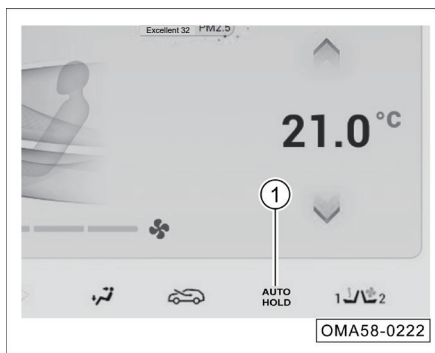

- When the engine is started, the driver's door is closed and the driver's seat belt is fastened, click the AV system bottom toolbar AUTO HOLD soft key ①, so that the indicator lamp lights up and the AUTO HOLD function is turned on. Click the soft key again, so that the indicator lamp goes out and the auto hold function is turned off.

#### Activation

When this function is enabled, it supports automatic brake application and release under stop & go conditions. When the driver brakes the vehicle, the vehicle will be automatically parked to avoid slide at startup.

#### Exit

Under the following conditions, AUTO HOLD will be disabled and the parking brake will not be locked:

1. Depress the accelerator pedal when starting.
2. The engine stops while the vehicle is running.
3. The EPB is manually released.
4. When pressing the brake pedal, click the AUTO HOLD button.



For the sake of safety, the AUTO HOLD will be disabled and the parking brake will be locked under one or more of the following conditions:

1. The ENGINE START/STOP button is set to "OFF" position.
2. The driver's door is opened or the seat belt is unfastened when the vehicle is stopped.
3. The AUTO HOLD button is pressed to disable AUTO HOLD.

### CAUTION

When driving into a mechanism such as a vehicle washing device that transports the vehicle with a conveyor belt, be sure to disable the AUTO HOLD, otherwise the vehicle cannot move or may run off the path.

## 5.3 Electronic service brake system

### 5.3.1 Electronic stability program (ESP)

ESP can effectively reduce the risk of sideslip.

ESP determines the driving intention of the driver according to the steering wheel angle and the vehicle speed, and compares it with the actual driving condition of the vehicle continuously. If the vehicle deviates from the normal driving route (such as sideslip), ESP will correct it by applying braking force to the corresponding wheels.

ESP returns the vehicle to a stable driving state through the torsional force generated by braking.

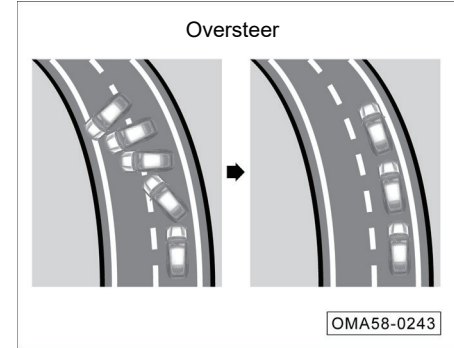

- When the vehicle tends to oversteer (i.e., drift), the system will apply braking force mainly to the front wheel on the outer side of the curve.

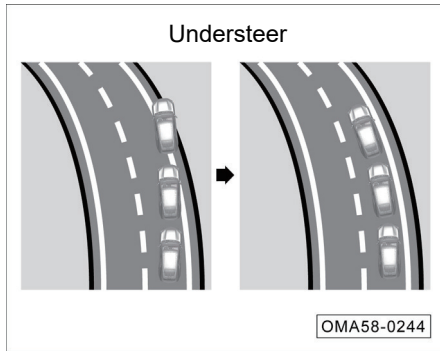

## 5. Driving guide

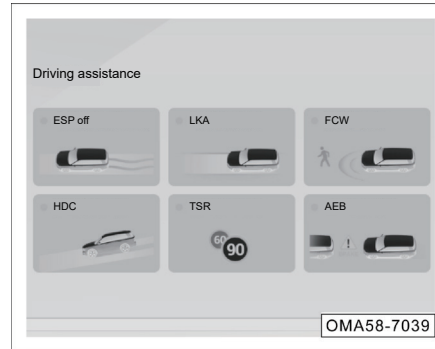

- When the vehicle tends to understeer (i.e., excessive turning radius), the system will apply braking force mainly to the rear wheel on the inner side of the curve.
- A vehicle without ESP deviates from the normal driving route due to sideslip. A vehicle with ESP can correct the braking force according to sideslip, to prevent deviation from the route.

### On and Off



ESP is on by default when the vehicle is running. Enter the AV system, click the driving control panel button  on the bottom toolbar to enter the driving control panel interface. If the “ESP” soft key is clicked, the ESP will be deactivated, the indicator lamp  on the instrument cluster will come on and an alarm message will be displayed.

Since the ESP works only when the vehicle is running, the ESP shall be activated for driving safety. The ESP can be disabled in the following special cases:

- when the vehicle runs with tire chains.
- when the vehicle travels on roads covered with deep snow or on soft grounds.
- when the vehicle is trapped on muddy roads, etc., and you need to move it back and forth.

### CAUTION

Improper operations or modifications of vehicle (such as modifications to the brake system, wheels, tires and other components) of the vehicle will affect the function of ESP.

### WARNING

- **Be sure to adjust the vehicle speed according to weather, road and traffic conditions at any time. Never risk driving merely by virtue of the additional safety functions provided by the systems.**
- **ESP cannot overcome the physical limit of road adhesion; be careful while driving the vehicle on a wet and slippery road or with a trailer coupled.**
- **The driver must adjust the driving style at any time according to the road and traffic conditions.**
- **ESP cannot reduce the risk of accidents caused by improperly driving such as driving at a high speed or driving too close to the vehicle in front.**

### Traction Control System (TCS)

ESP cannot reduce the risk of accidents caused by improperly driving such as driving at a high speed or driving too close to the vehicle in front. When the vehicle brakes on a smooth road, the wheels will slip, even making the direction out of control. Likewise, when the vehicle starts or accelerates rapidly, the driving wheel may also slip, and the direction may be out of control on a smooth road covered with ice, snow, etc. The TCS is used to automatically control the driving force during vehicle acceleration, so as to keep the slippage of tires within a reasonable range and maintain the driving stability of the vehicle.

### 5.3.2 Anti-lock brake system (ABS)

Anti-lock brake system (ABS) is an active safety device. When the vehicle is braking, if the front wheels are locked, the vehicle will be unable to make a turn. In this case, steering maneuvers necessary for the driver to avoid obstacles and pedestrians during braking and for driving on curves cannot be achieved. If the rear wheels are locked, the braking stability of the vehicle will be deteriorated, and the vehicle will drift or even turn around under the influence of small lateral force (such as lateral wind force). In addition, when the wheels are locked, local severe friction of tire will significantly shorten the tire life.

For anti-lock brake system (ABS) installed on the vehicle, an electronic control unit is added to the original brake system of the vehicle. Its function is to automatically adjust the wheel braking force and prevent the wheels from being locked during braking, so as to obtain the best braking performance and greatly improve the driving safety.

## 5. Driving guide

### Advantages of ABS

- Give full play to the effectiveness of brakes and shorten the stopping time and distance.
- Effectively prevent the vehicle from sideslip and drift during emergency braking, delivering good driving stability.
- Achieve steering during emergency braking, delivering good steering control.
- Avoid severe friction between tires and the ground, reducing the wear of tires.
- ABS is composed of anti-lock electronic control system and ordinary brake system. The anti-lock electronic control system consists of the sensor, the control unit and the actuator.

### Self-diagnosis of ABS

- The ABS ECU has self-diagnosis and fail-safe protection functions. When the vehicle power switch is set to "ON" position, ABS performs self-test. If ABS does not run normally, the ABS indicator lamp (🚗) will stay on. In this case, stop the ABS, restore normal braking, and go to the GAC Motor authorized shop for inspection and repair as soon as possible.

#### CAUTION

- Improper operation or modifications (such as modifications to the brake system, wheels, tires and other components) of the vehicle will affect the function of ABS.
- Tires must be of a specified size. Incorrect tire size or inconsistent sizes of all tires will affect the normal working of ABS.

#### WARNING

**Be sure to adjust the vehicle speed according to weather, road and traffic conditions at any time. Never risk driving merely by virtue of the additional safety functions provided by the systems.**

### EBD

As a part of ABS, the electronic brake force distribution (EBD) balances the distribution of braking force on the front and rear wheels according to the vehicle load during normal braking.

### Hydraulic brake assist (HBA)

Hydraulic Brake Assist (HBA) is capable of assisting a driver in braking a vehicle under an emergent condition. It determines whether it is necessary to carry out full braking based on the speed at which the driver depresses the brake pedal. As long as the driver always depresses the pedal to the bottom, the system will automatically increase the braking force to the activation threshold of the anti-lock brake system (ABS). If the driver relaxes the brake pedal, the system will reduce the braking force to the specified value.

#### WARNING

**HBA is only an assist system for improving the driving safety, but it is subject to the limitation of the laws of kinematics. Therefore, please adjust the driving speed according to the road conditions and traffic regulations.**

### 5.3.3 HHC

The hill-start hold control (HHC) is an active safety system from software function extension on the basis of ESP, which is mainly used to help the driver to pull away successfully on a steep slope.

When the vehicle is stationary, the HHC detects whether the vehicle is on a slope through the longitudinal acceleration sensor. Subsequently, when the vehicle goes up the slope from the stationary state (through forward traveling or reversing), the HHC will automatically enter the working state. At starting, when the driver releases the service brake pedal, the HHC will maintain the previous brake pressure to ensure that the vehicle still stops and gradually reduce the brake pressure with the increase of driving torque to realize the effect that the vehicle does not slide in the opposite direction without parking braking applied, which greatly improves the vehicle starting on a slope, frequent stops, starting, parking, etc.

At starting on a slope, the HHC prevents the vehicle from sliding backwards in the interval between the driver releasing the brake pedal and depressing the accelerator pedal, thus improving the safety and reliability of the vehicle during starting on a slope.

#### Working conditions



- The gearshift lever is in a position other than "P".
- The accelerator pedal is not depressed.
- The vehicle is stationary.
- Electric park brake is not applied.
- On the premise that the above basic conditions are met, the HHC is activated when the driver further depresses the brake pedal when the vehicle stops.

### 5.3.4 HDC\*

The Hill Descent Control (HDC) is a subsystem of ESP. If the driver does not depress the brake pedal while going downhill, HDC helps the driver to decelerate while going downhill via the ESP actively applying braking force.

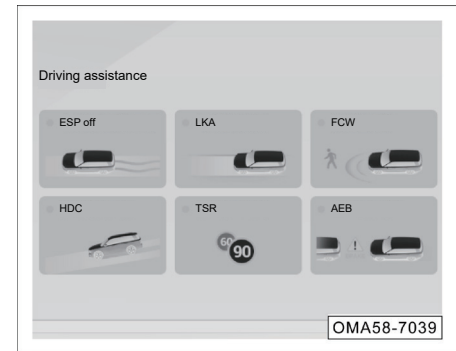
#### On and off



- With the ENGINE START/STOP button set to "ON" position, enter the AV system, click the driving control panel button  on the bottom toolbar to enter the driving control panel interface, and click the "HDC" soft key to activate the HDC. When the HDC is working, the corresponding indicator lamp  will stay on or flash, and a message reading "HDC is working"

## 5. Driving guide

---

will be shown on the instrument cluster display. If the HDC is faulty, the buzzer will sound, and an alarm message reading "Please check HDC" will be shown on the instrument cluster display.

- Press the button again to deactivate the HDC, and then the indicator lamp  goes out.

If the HDC function has been activated, the vehicle runs and maintains at the speed of at least 8 km/h while going downhill.

In addition, the driver can adjust the vehicle speed by depressing the accelerator pedal or the brake pedal. If the vehicle speed is within 8-35 km/h when the pedal is released, HDC will be activated again to keep the vehicle going downhill at the current speed.

- When the vehicle speed is higher than 60 km/h, HDC is automatically deactivated.
- When the HDC is active, ESP automatically intervenes in driving if the wheels slip excessively.

### NOTE

- When the HDC has a fault, the function is deactivated and a graphic prompt is displayed on the instrument cluster display with an audible alarm lasting for about 5 s. In this case, HDC cannot work properly, and the driver should depress the brake pedal for deceleration instead of trying to use the system to go down a steep slope. In addition, the driver should go to the GAC Motor authorized shop for inspection and repair as soon as possible.
- In some special environments, the HDC enters the thermal protection mode due to too high braking temperature. For example, when the system operates at a high ambient temperature for a long time, the temperature of the brake system constantly increases due to friction. When the upper limit of temperature has been reached, the HDC enters the thermal protection mode (i.e., the HDC function is active but inoperative) and is temporarily deactivated, and the vehicle shows signs of acceleration. When the temperature of the brake system drops to the level where the brake system can work effectively, HDC resumes normal operation.

### 5.3.5 HBC

When the vacuum booster fails, the HBC can compensate for the temporary low vacuum pressure caused by the vacuum failure and increase the brake pressure. At the same time, an alarm message will be displayed on the instrument cluster. Please contact the GAC Motor authorized shop for inspection and repair as soon as possible.

### 5.4 Driving assistance system

#### 5.4.1 ACC\*

The adaptive cruise control, abbreviated to ACC, can automatically adjust the distance from the vehicle ahead in the cruise control mode,

ACC detects the relative distance and speed with the vehicle ahead on the same path according to the signals from the MMW radar installed on the front of the vehicle and the IFC installed on the front windshield:

- When there is a lead vehicle and it stops, the ACC will stop the ego vehicle automatically; If the vehicle in front starts, ACC will control the vehicle to start and run automatically again in a short period of time. After stopping for a period of time, the vehicle can be started by operating the  button or accelerator pedal as the vehicle ahead is started.
- When the speed of vehicle ahead is lower than the target speed set by the driver, ACC controls your vehicle at a safe distance from the vehicle ahead.
- When there is no vehicle ahead, ACC controls the vehicle to drive at the target speed set by the driver.

#### NOTE





Precautions for use of radar and IFC sensors. => See page 171

#### WARNING

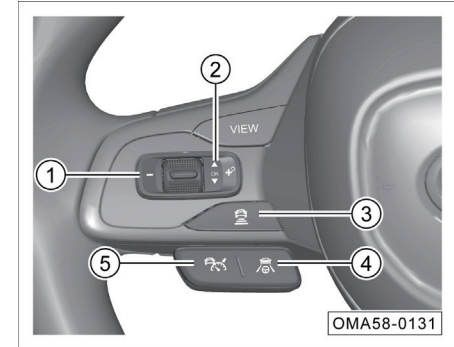
- **ACC is not a safety system, obstacle detector, collision warning device or anti-collision system, but a comfort system. The driver must always maintain control of the vehicle and take full responsibility for the vehicle.**
- **Always use the ACC system carefully based on the current visibility, weather conditions, road and traffic conditions. The driver must remain in control of the vehicle and be fully responsible for the vehicle's speed and the distance from other vehicle.**
- **ACC cannot substitute for driver's attention and judgment. The driver is always responsible for ensuring that the vehicle travels safely at an appropriate speed and at an appropriate distance from other vehicle.**

#### Button operations





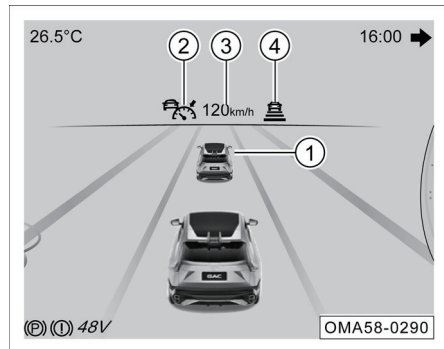

- ①  : Deceleration key
- ②  : Recovery/synchronization/acceleration key
- ③  : Adjusting the distance/time interval between vehicles
- ④  : ICA On/Off/switching to ICA
- ⑤  : ACC On/Off/switching to ACC

## 5. Driving guide

### Interface description



- ① Indicates the detected vehicle ahead.
- ② ACC indicator lamp:
  - The blue ACC indicator lamp  lights up to indicate that the ACC is working and there is a target vehicle ahead. The gray ACC indicator lamp  lights up to indicate that the ACC is ready and there is target vehicle ahead.
  - The blue ACC indicator lamp  lights up to indicate that the ACC is working and there is no a target vehicle ahead. The gray ACC indicator lamp  lights up to indicate the ACC is ready and there is no target vehicle ahead.

-  The yellow ACC indicator lamp lights up to indicate that there is a fault, and you should go to the GAC Motor authorized shop for inspection and repair in time.

- ③ Indicates the cruising speed set last time.
- ④ Set cruise control time interval with the vehicle ahead.

When the braking capacity of ACC is not enough to maintain a proper distance from the vehicle ahead, ACC will send a “driver hands-on operation request”, and the instrument cluster will give a visible alarm and an audible alarm. In this case, the driver shall depress the brake pedal to reduce the vehicle speed according to the system requirements.

### Activating ACC

- After the ENGINE START/STOP button is set from the “OFF” position to the “ON” position each time, ACC will automatically enter the ready state. If the  button is pressed, the corresponding blue indicator lamp on the instrument cluster will come on, and the vehicle will enter the ACC status.

#### NOTE

- The minimum cruising speed that can be set is 15 km/h.
- When the transmission is in other positions than D, ACC cannot be activated.







### WARNING

- When the vehicle is in the “engine running” state, the transmission is in the “D” position, press the steering wheel  button , and the stationary vehicle will automatically enter the driving state after the conditions are met, so be careful.
- After the vehicle enters the ACC control state from the stationary state, the vehicle speed may increase suddenly. Please ensure the safety around the vehicle to avoid unnecessary accidents.

### Deactivating ACC

ACC can be deactivated by:

- Open the driver's door.
- unfastening the driver's seat belt.
- Step on the brake pedal.
- setting the gearshift lever to a position other than D.
- pressing the  button (after that, the corresponding indicator lamp on the instrument cluster will turn gray, ACC will be deactivated, but the set speed will be kept).
- pressing the EPB button.
- deactivating the ESP.
- Turn on the HDC system.
- when the Autohold function is activated.

If deactivated by the following ways, ACC may be resumed through the  button:

- depressing the brake pedal.
- setting the gearshift lever to a position other than D.
- pressing the  button .
- pressing the EPB button (it is required to release EPB).
- switching off the ESP (it is required to switch on the ESP for resuming the ACC).
- when the Autohold function is activated (exit the Autohold first).

## 5. Driving guide



### Resuming ACC

When the corresponding gray indicator lamp on the instrument cluster comes on, ACC can be reset by the following ways:



- pressing the  button, after which the corresponding indicator lamp on the instrument cluster will come on in blue, the vehicle speed will return to the value set during the last cruise control, and the cruise control will be resumed.
- If no cruising speed has been set, ACC will set the current vehicle speed as the cruising speed (if the current vehicle speed is less than 15km/h, the cruising speed will be set at 15km/h).

### Increasing cruising speed

To increase the vehicle speed, please perform the following operations:





- Depress the accelerator pedal to increase the vehicle speed to a target value and press the  button (keep the accelerator pedal depressed) for cruising at the increased speed.
- Press the  button ; each time the button is pressed, the vehicle speed increases by 5km/h.
- Press and hold the  button to increase the cruising speed at an increment of 5 km/h.

### NOTE

- The settable maximum cruising speed is 130 km/h.
- When the accelerator pedal is pressed to accelerate, the vehicle temporarily exits ACC and accelerates with according to the driver's intention. When the accelerator pedal is released, the vehicle resumes ACC as well as the set cruising speed.
- When the accelerator pedal is depressed to make the vehicle speed exceed 135 km/h, the vehicle will exit the ACC by itself. After the vehicle speed is reduced to 130 km/h, the ACC can be reactivated by pressing the  key or  key shortly again.

### Decreasing cruise speed

To reduce the vehicle speed, please perform the following operations:

- Press the  button; each time the button is pressed, the vehicle speed reduces by 5km/h.
- Press and hold the  button to reduce the cruising speed at a decrement of 5 km/h until the button is released or the cruising speed is 15km/h.
- During the cruising process, slightly depress the brake pedal (with ACC deactivated), keep braking until the target speed is reached, and press the  button to cruise at the current speed.
- During the cruising process, press the button of steering wheel (with ACC deactivated), make the vehicle coast or slightly depress the brake pedal until the target speed is reached, and press the  button to cruise at the target speed.





### Controlling ACC distance

After the ENGINE START/STOP button is set to "ON" position, when ACC is activated, the default time interval setting is in the fourth range (the time interval in the fourth range is the longest).

By pressing the  button, the distance setting can be changed recurrently in the order of "fourth range → third range → second range → first range → fourth range...". At the same time, the instrument cluster will display the same number of cross bars as the ordinal number of the range.

### Activating ACC after following stop

In the process of following a vehicle in front, your vehicle will also be stopped if the vehicle in front is stopped. ACC will keep the vehicle stationary through active pressurization via the ESP during a period of time after following stop. After a period of time, the ACC will keep the vehicle stationary by activating EPB. When the vehicle in front leaves, ACC of your vehicle may be activated as follows:

1. If the ACC indicator lamp  is blue, ACC can be reset actively and re-drive the vehicle after the vehicle ahead is driven off.
2. If the gray ACC indicator lamp  is on and EPB is not activated and Autohold is not activated, the instrument cluster will show "Waiting for ACC" and the driver can press the accelerator pedal or the  key to resume ACC and drive the vehicle again
3. If the gray ACC indicator lamp  is illuminated and EPB is activated, the driver needs to release EPB first and press the  button after EPB is released to resume ACC and re-drive the vehicle again.

## 5. Driving guide

---

### System limitations

As limited by physical laws, ACC has a certain system limitation. In some driving environments, the driver may feel a response lag of ACC or the failure of ACC to control the vehicle as expected, so he or she must always be ready to control the vehicle.

The following conditions affect functions of the radar system sensor, so the driver must be particularly alert under these conditions:

1. Decelerating to stop. If the vehicle ahead stops by emergency braking, ACC will also decelerate your vehicle or send a hands-on operation request. The driver should actively intervene in the brake according to the hands-on operation request to stop your vehicle completely.

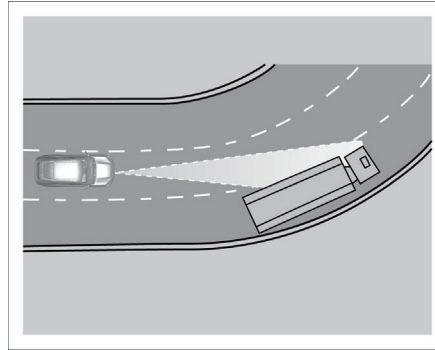

2. Driving through a curve. During driving through a curve, the RPA sensor may fail to capture the vehicle ahead, or may not be able to react to vehicles in adjacent lanes. In this case, the ACC may brake the vehicle, reduce the vehicle speed, or make no response to the vehicle ahead. At that time, step on the brake pedal or manually cancel ACC.

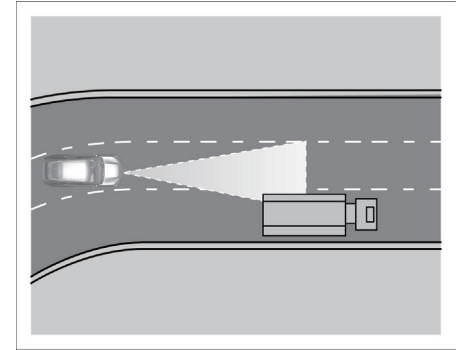

3. Driving out of a curve. During driving out of a long curve, as ACC will calculate the lane in advance, the radar may respond to the vehicles in adjacent lanes and apply the brake of your vehicle. This braking process can be interrupted by stepping on the accelerator pedal.

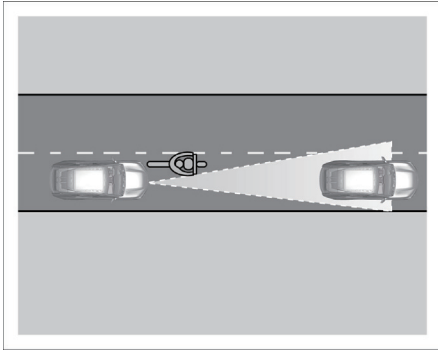

4. Narrow vehicles and Z-shaped traffic in front. The narrow vehicles and Z-shaped traffic in front can be detected by the radar sensor only when they enter the detection range of the radar sensor. That is to say, the system cannot identify vehicles out of the detection range of the sensor. ACC may be unable to identify narrow vehicles such as motorcycles, and has a risk of failing to accurately identify the distance from modified vehicles and vehicles involving non-standard transportation in front, so it is not recommended to take such vehicles as the target vehicle ahead.

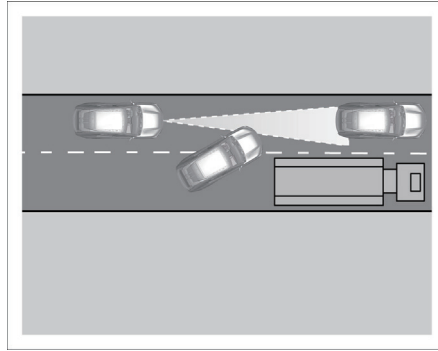

5. When another vehicle changes the lane. When a vehicle in the adjacent lane goes into the ego lane, if it does not enter the detection range, it could not be detected by the RPA sensor, thus resulting in a response lag of ACC.

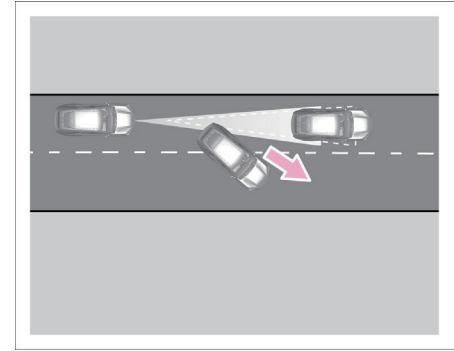

6. If the target vehicle in front is driven out suddenly and a stationary vehicle appears at close range, the radar sensor and brake actuator will incur a response lag, causing delayed braking response.
7. Factors that may deteriorate the function of the sensor.
- Heavy rain, water mist, ice and snow or sludge may deteriorate the function of the RPA sensor, causing the ACC to be temporarily deactivated. At the same time, the instrument cluster displays the following text messages: "Cruise control system working conditions are not met" or "MRR is blocked". The ACC and FCM cannot function at this time.

## 5. Driving guide

- Frosting or fogging of front windshield due to temperature difference or frost in low-temperature and alpine areas, which will obstruct the IFC sensor, and cause display of following telltales on the instrument cluster: “The working conditions of the cruise control system are not met” or “MRR is blocked”. The ACC system and FCM cannot function at this time.
- 8. Brake overheating. If the brake is overheated due to emergency braking or driving down a steep slope, ACC will be deactivated automatically, and meanwhile the instrument cluster will display a telltale reading “The working conditions of the cruise control system are not met”. After that, ACC can no longer be activated. ACC can only be reactivated when the brake temperature drops to a reasonable degree.

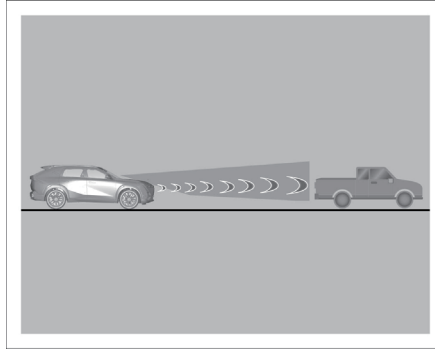

- 9. It is not recommended to use the ACC under the situation of urban traffic congestion or poor visibility (night driving/backlighting/rain/snow/dense fog, etc.). ACC may not take braking measures in face of people, animals, narrow vehicles such as bicycles, motorcycles or electromobiles, low-bed trailers, approaching or stationary vehicles, and low-speed or stationary trucks/small pickup trucks, so the driver should be particularly alert and always be ready to take over the vehicle.

### WARNING

- The ACC cannot address all driving scenarios and traffic, weather and road conditions.
- ACC function is only a supplementary driving assistance function. Even if used, this function cannot replace your attention and judgment. It is your responsibility to maintain a safe distance and speed, and, if the ACC fails to maintain a proper speed or a proper distance from the vehicle ahead, you must take over the ACC.
- The hands-on reminder of ACC only warns the driver of vehicles detected by its radar and IFC sensor, so ACC may not send an alarm, or may send an alarm after a certain delay. Never wait for an alarm to be given and step on the brake when the situation requires.

### WARNING

- For the sake of safety, it is not allowed to use ACC under conditions such as urban driving, traffic jams, multi-curve roads and poor road conditions (e.g. icing, fog, gravel, heavy rain, and phenomena prone to water skiing), because there is a danger of accident.
- The ACC is not a collision avoidance system. If your vehicle is getting closer and closer to the lead vehicle at a speed higher than that of the lead vehicle and the braking effect of ACC is unable to stop the vehicle safely before a collision with the lead vehicle, the driver must depress the brake pedal to reduce the vehicle speed.
- Do not activate ACC during driving in roadless areas or on earth roads. ACC can only be activated on flat roads paved with pitch, cement, etc.

### WARNING

ACC does not respond or responds only to a limited extent to the followings:

- Large speed difference with the vehicle ahead.
- Driving in different lanes, lane changes or driving on curves with small radius.
- Pedestrians, animals, bicycles, tricycles, stationary vehicles or unexpected obstacles.
- Complex traffic conditions.
- Oncoming traffic or cross traffic.
- Low-bed trailers or trucks, and vehicles with irregular or non-standard characteristics.

Therefore, be sure to notice traffic conditions and respond accordingly. Do not wait for the system to identify the target or apply the brake, but apply the brake as needed.

### NOTE

- Do not bump the radar sensor. If the sensor is misaligned due to bumping, the system performance will still deteriorate even after repair and correction and even the system will be shut down.
- If the surface of the radar or IFC sensor is dirty or covered by heavy rain, ice, snow, sludge, etc., ACC may not function, and the instrument cluster will display the message “MRR is blocked” and “IFC is blocked”. After the dirt is cleaned off the sensor surface, the function will return to normal.
- Do not spray the front bumper with car paint or attach decorations such as stickers, as this may cause a decrease in MRR performance.
- ACC may not respond to people, animals and vehicles crossing or approaching the ego vehicle in the same lane.

## 5. Driving guide

---

### i NOTE

- When driving through crossroads, speed bumps, steep roads and zebra crossings, or at changing lanes, highway access, ramps or construction sections, it is required to exit ACC for manual driving, lest the vehicle should be automatically accelerated to the set speed, causing traffic accidents.
- ACC can automatically drive the vehicle out after a short stop or confirmation from the driver (control of buttons or accelerator pedal). During this period, the driver must ensure that there are no obstacles or other traffic participants such as pedestrians/two wheeled vehicles, ahead of the vehicle.
- If ACC fails to function normally, do not continue to use it. It is recommended to go to the GAC Motor authorized shop for inspection and repair in time.

### i NOTE

- ACC may not react under certain circumstances. For example, when your vehicle approaches a stationary obstacle such as a broken-down vehicle or a vehicle stuck in traffic jams, or when a vehicle traveling in the same lane approaches your vehicle.
- ACC can only achieve limited braking force, not emergency braking.
- Do not put your foot on the accelerator pedal unintentionally, otherwise the ACC will no longer brake the vehicle. This is because the depressing of accelerator pedal will cause excessive control of vehicle speed and distance.
- When your vehicle is traveling in heavy rain or snow, and ACC is difficult or unable to identify the vehicle ahead, ACC shall be deactivated.

### i NOTE

- When ACC is on, the ACC status displayed by the instrument cluster may be overwritten by other functions (for example, during a call).
- When the system automatically applies the brake to the vehicle after the ACC is activated, a sound different from the manual braking will appear, or the brake pedal will automatically be pressed down, which is normal. This sound and pedal action are caused by the operation of the brake system; there is no need to worry.
- For safety, the stored cruising speed will be deleted after the vehicle power is turned off.
- You can press the accelerator pedal to increase the speed at any time. After releasing the accelerator pedal, the system will adjust the vehicle speed back to the previously stored vehicle speed.
- In the tunnel, the radar and IFC may enter the blind mode, and the ACC may be temporarily turned off.



### Display of longitudinal distance from vehicle ahead

ACC detects the relative distance between the lead vehicle and the ego vehicle on the same path according to the radar installed at the front of the vehicle and the IFC on the windshield, and displays it on the instrument cluster display.

- When there is a vehicle ahead, if the display of longitudinal distance from vehicle ahead is selected, the relative distance value of the vehicle ahead can be displayed on the instrument cluster.
- When there is no vehicle ahead, the instrument cluster cannot display the relative distance value of the vehicle ahead.

### On or off

When the vehicle power is in the "ON" position, the FCW and AEB will be automatically turned on.

To turn on/off the display of longitudinal distance from vehicle ahead manually, set in the AV system "Settings → ADiGO intelligent driving → ADiGO driving assistance → Longitudinal distance from vehicle ahead".

### NOTE

The radar sensor and IFC are limited in detection and cannot recognize vehicles outside the detection range of the sensor.

### WARNING

- **Be sure to use longitudinal distance from vehicle ahead carefully according to the visibility, weather conditions, road and traffic conditions at that time. The driver must always keep the control of vehicle and take full responsibility for the speed of the vehicle and the distance from other vehicles.**
- **The driver cannot judge and make decisions completely according to the longitudinal distance from vehicle ahead. The driver is always responsible for ensuring that the vehicle travels safely at an appropriate speed and at an appropriate distance from other vehicle.**

### 5.4.2 Integrated cruise assist (ICA)\*

The integrated cruise assist system is abbreviated as ICA. ICA can automatically adjust the distance between the ego vehicle and the lead vehicle when cruising, keep the ego vehicle in the middle of the lane, and apply the cruising speed of 0~130 km/h.

ICA detects the relative distance and speed of the vehicle ahead in the same path according to the MMW radar installed on the front of the vehicle and the IFC installed on the front windshield, and detects the lane markings on the road surface through IFC.

ICA can improve driving comfort and provide a more relaxed driving experience, such as long-distance driving in smooth traffic on the highway.

### NOTE

Precautions for use of radar and IFC sensors. => See page 171

## 5. Driving guide

### Operation instruction

Press the button  on the left side of the steering wheel to turn on ICA.



After turning on ICA, press the operation mode of ACC to turn on or activate ICA. The cruise mode can be switched when ACC is deactivated, turned on or activated. => See [page 139](#)

The system has a cruise control mode memory function, and when the vehicle is started, the cruise mode will be the same as it was selected when the vehicle was shut down last time.

When the ICA system has a specific fault that does not affect ACC, the cruise mode will automatically jump back to the ACC. At this time, the driver can no longer choose to enter the ICA, but the ACC can still be used normally.

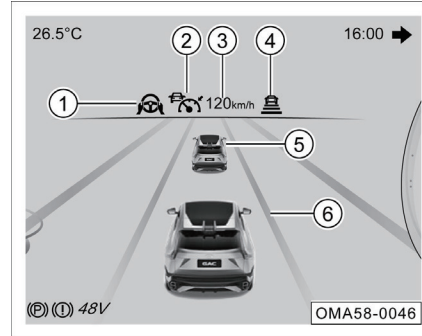
### Interface description



- ① Lateral control status indicator lamp:
  - The middle steering wheel displays blue  when the lateral control is active and gray  when standby.
  - The hands icon on the steering wheel icon stays on when the driver's hands on steering wheel is detected.
  - During system activation, if it detects that the driver's hands are off the steering wheel for about 14 s, the hands icon will flash.
  - The system can also dynamically pop up the text prompt "Please turn steering wheel gently" and sound the corresponding prompt according to the

actual situation of the driver holding the steering wheel.

- ② ACC indicator lamp
- ③ Cruising speed set previously
- ④ Set cruising distance from vehicle ahead
- ⑤ Detected vehicle ahead
- ⑥ Lane marking

### NOTE

When the instrument cluster is in organic theme, the interactive display of ICA will be switched to the simplified display version, only displaying the target lead vehicle and the lane marking of ego vehicle.

### Lateral control

When the function of ICA is activated, the lateral control will be automatically activated if ICA detects effective lane markings on both sides.

ICA will keep the vehicle traveling in the middle between the lane markings on both side.

Lateral control is suppressed when:

- Lane marking curvature is too high or missing
- Under intense driving conditions
- Turn signal lamp is turned on
- Hazard warning lamp is turned on
- Driver turns steering wheel
- If the driver's hands are off the steering wheel for a long time, the system will prompt to take over
- ACC exits => [See page 141](#)

The ICA system can only use limited capability of steering system, so it cannot cover all driving conditions. The driver must keep both hands at all times to control the steering wheel and drive carefully.

When the ICA system intervenes in the steering wheel for lateral assist control, the driver can still turn the steering wheel to control the vehicle. When the driver feels that the torque applied by the system is improper, the vehicle can be controlled to drive according to the driver's intention at any time.

### Hands-on reminder



When ICA detects that the driver's hands have been off the steering wheel for a long time, the system will issue hands-on reminder and the instrument cluster will display the above figure, accompanied by a buzzer.

The driver shall immediately hold the steering wheel immediately after receiving the hands-on reminder. Don't panic or turn the steering wheel fiercely. When the ICA system detects

the hand torque applied to the steering wheel, the driver's hands on the steering wheel can be recognized and the hands-on reminder will be canceled. The ICA automatically reactivates lateral assist.

Note that the lateral assist of the ICA function will be deactivated after the steering wheel hands-on reminder is issued and the driver does not take over in time.

The system may misjudge the driver's hands off the steering wheel when the driver's hands are lightly holding on the steering wheel. In this case, when the system sends a steering wheel hands-on reminder, the driver only needs to hold the steering wheel slightly or shake the steering wheel slightly, the system can detect the torque on the steering wheel, and the hands-on reminder will be canceled.

## 5. Driving guide

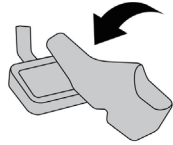

Please take over now!

OMA58-0048

The ICA system can only use the limited braking ability of the service brake system. When the system requires the driver to intervene in braking, the instrument cluster shows the above figure and the buzzer sounds. When receiving the hands-on reminder, the driver shall immediately depress the brake pedal for proper braking.

After the brake pedal is depressed, the ICA will exit. If the emergency is eliminated and the ICA needs to be reactivated, operate to restore ACC or set the ACC button. => [See page 139](#).

### Intelligent avoidance

When the ICA is activated, the intelligent avoidance system will automatically control the vehicle to avoid when it recognizes a specific side risk (such as a large vehicle in the adjacent lane). The intelligent avoidance function can be turned on or off in the AV system "Settings → ADiGO intelligent driving → ADiGO active safety assistance → Intelligent avoidance".

The system has an on/off status memory function, and after the vehicle is started, the on/off state will be the same as it was set when the vehicle was shut down last time.

When the intelligent avoidance function is activated, the icon color of the target vehicle in the adjacent lane on the instrument cluster will turn yellow, and the text prompt "Under intelligent avoidance" will pop up automatically in the pop-up window.

### Limitations

The ICA system is limited in the functions of both steering and brake systems, so it is not able to maintain proper stop distances in all road conditions or keep the vehicle in its lanes in all conditions.

The ICA system may incorrectly detect the lane markings or fail to detect the lane markings, and may incorrectly detect the target vehicles or fail to detect the target vehicles ahead. Under the following situations, the system may be affected, misoperated, or inoperative even if the function is turned on and shows that it has been activated:

- Poor line of sight, such as snow, rain, fog or water spots.
- Dirt or fog on the front windshield, or obstruction in front of the IFC.
- Too high temperature around the IFC due to direct sunlight.
- Poor vision due to direct sunlight, incoming vehicle lights, reflected light from road water, etc.
- Sharp changes in illumination conditions, such as entering/exiting tunnels.

- Failure to turn on headlamps at night or in the dark tunnel.
  - No lane marking, or difficulty in distinguishing the lane marking color from the road surface color.
  - Unclear lane markings, such as too thin, worn, blurred or covered by dirt/snow.
  - Too wide or narrow lanes.
  - Increased or decreased number of lanes or complicated lane markings.
  - More than two lane markings on the left and right sides of the vehicle.
  - Marks or objects similar to lane markings on roads.
  - Shadows of isolation belt or other objects casted on lane markings.
  - Short-term change of marking, such as ramp or highway exit.
  - Driving on steep slopes or curved roads.
  - Close distance from the vehicle ahead or lane markings blocked by the vehicle ahead.
  - Vehicle severely shaken.
- The longitudinal control of the ICA system is based on ACC. See the relevant chapter of ACC for more limitations => [See page 144.](#)
- The lateral control performance of the system may be affected under the following conditions:
- The vehicle is overloaded.
  - The tire pressure is abnormal.
  - The road is uneven.
  - There is strong crosswind.
  - The driver modifies the parts related to vehicle control.
  - The parts related to vehicle control are replaced with non-genuine parts.
  - The parts related to vehicle control are improperly assembled.

### **i** NOTE

When the ICA system is assisting in the control of steering wheel, the driver can still turn the steering wheel to control the vehicle. When the torque applied by the system is found improper, the driver can control the vehicle to travel according to his intention when required.

## 5. Driving guide

---

### CAUTION

- If the ICA is deactivated for any reason, such as a brief exit due to lane markings, it will be automatically restored when the operating conditions are met.
- When judging that the ICA system does not control the vehicle properly, the driver can hold the steering wheel firmly for appropriate control, and the ICA function may be interrupted by the driver's operation on the steering wheel.
- The ICA function can be interrupted by the driver's operation, such as depressing the brake pedal, quickly depressing the accelerator pedal, pressing the ICA button, unfastening the seat belt, pressing the hazard warning lamp, etc. Please keep your hands on the steering wheel.

### WARNING

- **The ICA is only a driving assistance function and cannot cope with all road, traffic and weather conditions. The driver is always fully responsible for driving, and should always pay attention to the road conditions and actively control the vehicle.**
- **The driver must always hold the steering wheel and actively control the vehicle. When the ICA system does not provide proper steering assistance or headway, the driver shall intervene in time.**
- **Before using the ICA, the driver must read through all chapters on this function in the user manual to understand the system limitations of this function. Before using this function, the driver shall be aware of these limitations.**

### WARNING

- **Improper use or negligence of the ICA may cause accidents. Therefore, the driver should always control the vehicle, maintain an appropriate vehicle speed and distance between vehicles, and keep the vehicle running correctly in the lane, even if the ICA is being used.**
- **The ICA system is not a collision avoidance system. When the system is not properly controlled, the driver must intervene in.**
- **Do not use ICA in urban traffic, intersections, waterlogged and snowy roads, bad weather, mountain roads, undulating roads, highway entrances and exits, etc. Do not use the ICA when a trailer is connected to the vehicle.**

### WARNING

- The ICA system doesn't always identify lane markings. The lane markings may be missed or misidentified due to severe weather, poor lighting, sharp light changes in and out of tunnels, accumulated water or snow on the road surface, damaged, blurred or non-standard lane markings, shadows cast on the road surface, braking marks, surrounding vehicles, maintenance facilities, guardrails and other obstructions, rapid changes in lane markings (such as merging and split), etc. Therefore, the ICA may not generate lateral assist torque when needed, or may generate unnecessary lateral assist torque by mistake.
- The ICA system can only use limited capability of steering system, so it cannot cover all driving conditions. The driver must keep both hands at all times to control the steering wheel and drive with care. Pay attention to holding the steering wheel or reducing the speed appropriately at high speed in curves.

### WARNING

- The ICA system cannot apply brakes for pedestrians, animals, foreign objects, low platform trailers or oncoming vehicles.
- The ICA system does not work on all traffic conditions. Under the working conditions such as too high curvature of lane marking before a sharp turn and encountering a section without lane marking, the lateral assist may suddenly exit. Be sure about always holding the steering wheel and actively controlling the vehicle.

### 5.4.3 Forward collision mitigation (FCM)\*

The FCM detects the relative distance and speed between the object on the front path and the vehicle according to the MMW radar installed in the front of the vehicle and the IFC on the front windshield, integrates other operation behaviors of the driver (such as depressing the brake pedal, depressing the accelerator pedal, etc.), evaluates the degree of pre-collision risk, and sends an alarm to remind the driver to take measures in time when there is a collision risk; when the system detects that a collision is about to occur, it will automatically brake the vehicle; when the driver is braking, but the braking force is not enough to avoid a collision, the system will automatically increase the braking force to avoid or mitigate the collision.

## 5. Driving guide

### Detectable objects:

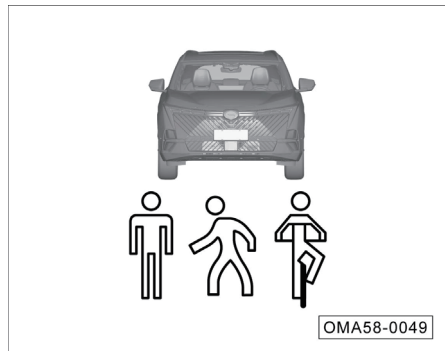

- Vehicle.
- Two-wheeler
- Pedestrians

### **i** NOTE

Refer to precautions for use of radar and IFC sensor. => See page 171

### FCW

It detects the objects ahead through the MMW radar installed on the front bumper and the IFC on the front windshield, and alerts the driver of the impending collision.

The alarms of FCM include three types of prompts:

#### 1. Proximity warning

When the warning of FCM is triggered, the instrument cluster FCW indicator lamp  flashes, and the instrument cluster issues an audible warning and animation prompt.

#### 2. Short braking

When the ego vehicle has a high collision risk on the moving target vehicle, the short braking is triggered to better remind the driver that the brake shall be applied immediately.

### AEB

It detects the objects ahead according to the MMW radar installed on the front bumper and the IFC on the front windshield, enters the emergency braking state according to the impending collision of the vehicle, provides assistance during braking, and triggers the AEB function.

### Active braking level

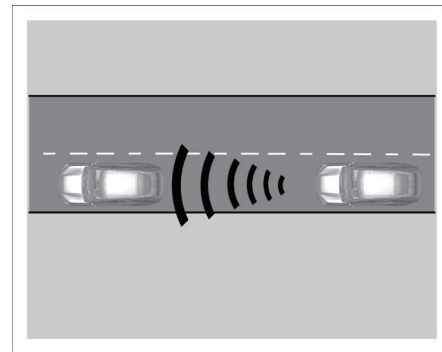

- Level 1 braking: Short braking is applied when approaching the vehicle ahead.



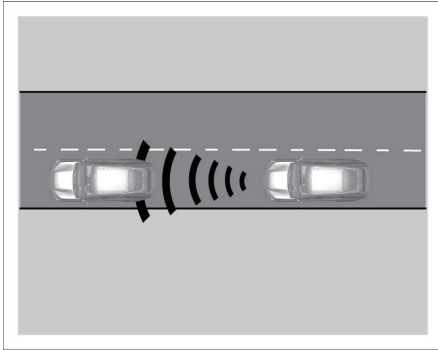

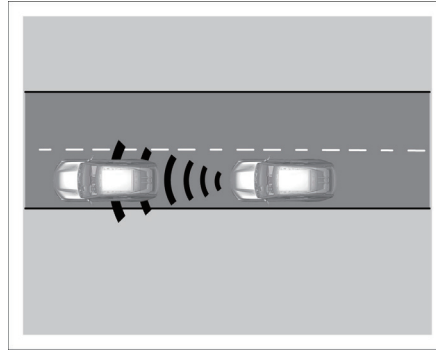

- Level 2 braking: Slight automatic emergency braking is applied in the case of further approach.

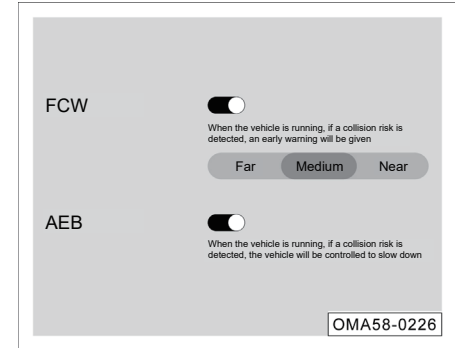

- Level 3 braking: Full braking is applied automatically when a rear-end collision is inevitable.

### On and off



- When the vehicle power is in the "ON" position, the FCW and AEB will be automatically turned on.
- In the AV system "Settings → ADiGO intelligent driving → ADiGO active safety assistance → FCW", press the right  soft key to turn the "FCW" and "AEB" on or off.
- When turning off the FCW and AEB, the multi-function touch screen will pop up the secondary confirmation window, and click "Confirm" or "Cancel" to confirm the operation.

## 5. Driving guide

---

### **i** NOTE

- The warning distance “far, medium and near” can be set after the FCW is turned on. The FCW distance has a memory function to memorize the last set warning distance.
- After the FCW and AEB are turned off, the systems will no longer warn or brake for vehicles and pedestrians.
- After the FCW or AEB are turned off, if the vehicle power is switched from the “OFF” position to the “ON” position again, the FCW and AEB will be automatically turned on by default.

### **System limitations**

FCM have physical and system limitations; for example, FCW and AEB functions may be inadvertently triggered or delayed by driver interference in some situations. Therefore, please stay alert at all times and take over control if necessary.

The following conditions may cause delayed operation or inoperation of the FCM:

- The ground clearance of vehicle ahead is very high, such as a semi-trailer.
- The rear of vehicle ahead is low, such as a low-bed trailer.
- The shape of vehicle ahead is irregular, such as a tractor and a straddle truck.
- The brightness of the surrounding environment changes suddenly, such as tunnel entrance and exit.
- The rear of vehicle ahead is small, such as an unladen truck.
- A detectable object ahead performs emergency acceleration, deceleration and steering.
- A detectable object ahead suddenly comes in front of the vehicle.
- The vehicle ahead is a bicycle with a special shape, such as a multi-person bicycle.
- The vehicle is at extremely high speed.
- The vehicle is driven on a slope.
- The vehicle is running on a narrow curve.
- The accelerator pedal is depressed with force or the vehicle accelerates rapidly.
- The assist function is deactivated or operates abnormally.
- The ESP is manually deactivated.
- The vehicle enters ESP control.
- The surface of the area where the IFC is located or the surface of the radar sensor is dirty or covered by foreign objects.
- The vehicle is reversing.
- Traffic is chaotic.
- The body tows other vehicles.
- Pedestrians stand on traffic safety islands or bends.
- Pedestrians are completely or partially covered by other objects, such as workers holding ladders, pedestrians holding umbrellas, etc.

- Pedestrians wearing fancy clothes or masks, for example, carnival costumes
- Poor visibility, such as sunset, night, snow, heavy rain, fog, backlight, etc.

The following conditions may cause the system to operate when a vehicle collision is unlikely:

- There is a detectable object in front of the vehicle.
- The ego vehicle is overtaking a vehicle changing lane or turning right/left.
- The ego vehicle is overtaking a vehicle ready for right/left turn.
- There is a detectable object at the bend entrance.
- The vehicle changes lanes in the process of overtaking the detectable object.
- The vehicle is approaching the front detectable target in the winding lane or when changing the driving route.
- The vehicle runs under portal frames, billboards, road signs, etc.
- There are manhole covers, steel plates and other metal objects in front of the vehicle.

- The vehicle approaches a roadside telegraph pole, railing, tree, etc.
- When driving through grass, branches, banners and other objects that may come into contact with the vehicle.
- When driving near an object that reflects radio waves.

### WARNING

**The AEB function must be turned off in the following cases:**

- **The vehicle is towed**
- **The vehicle is on the hub test bench.**
- **The radar sensor or IFC sensor is faulty.**
- **There is an external force (such as rear-end collision) acting on the radar sensor.**

### WARNING

- **The FCM can improve your driving safety, but it is impossible to violate the laws of physics. Do not use the convenient functions provided by FCM to drive at risk. The driver must always be ready to apply the brakes of the vehicle, so as to reduce the speed or avoid the obstacle.**
- **The FCM only alarms and mitigates the collision of vehicles/pedestrians that have been detected by the radar and IFC sensor, so it may not react, or the reaction may have a certain delay. Do not wait for the FCM to work, and the driver shall apply the brake if necessary.**
- **The FCM only provides the driver with the warning to avoid collision and the limited braking to reduce collision injury. It is impossible to prevent the vehicle from accidents or personal injury autonomously. The driver must always control the vehicle and take full responsibility for the speed of the vehicle and the distance from other vehicles.**

## 5. Driving guide

### WARNING

- When the FCM is turned on, the driver must maintain control of the vehicle at all times while driving and is fully responsible for the vehicle's speed and the distance from other vehicle.
- Never ignore the lit up warning lamps and instrument cluster display reminders, otherwise traffic accidents and serious injuries may occur.
- Therefore, always pay attention to traffic conditions and do not rely too much on AEB function. The AEB function is only a driving assistance tool and it is the driver's responsibility to maintain a proper distance from the vehicle ahead and to control the speed for timely braking. Prepare for braking or steering if necessary.

### NOTE

- Depressing the accelerator pedal or turning the steering wheel will terminate the FCW alarm and AEB intervention.
- In complex driving environment (for example, on a circuitous road), the FCW and AEB may give unnecessary alarm and brake intervention.
- When the AEB is triggered, the vehicle will be braked, and the brake pedal may feel vibration or become hard, which is a normal phenomenon.
- When affected by factors such as electromagnetic field interference, the target's own reasons or the environment, detection will be interfered and the performance will be degraded.

### 5.4.4 Traffic sign recognition (TSR)\*

The traffic sign recognition is abbreviated as TSR. The TSR detects the speed limit sign on the road ahead through the IFC installed on the front windshield, and at the same time integrates the data from the AV system navigation to provide the driver with speed limit information, and reminds the driver of speeding when the speed limit is exceeded.

#### On and off

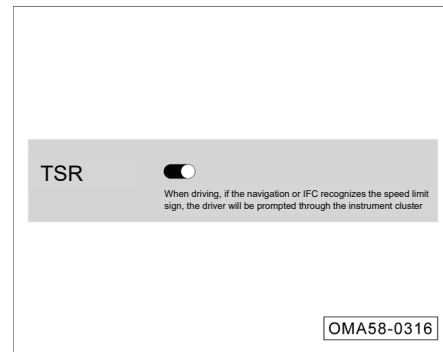

The TSR function can be turned on or off in the AV system "Settings → ADiGO intelligent driving → ADiGO active safety assistance → TSR".

When this function is turned on, if the navigation or IFC recognizes the speed limit sign on the road ahead, the speed limit sign will be displayed on the instrument cluster; If the current speed displayed on the instrument cluster exceeds a certain speed limit threshold, the speed limit sign icon on the instrument cluster will flash continuously.

### **i** NOTE

The system has on/off status memory function. After the vehicle is started, the on/off state will be the same as it was set when the vehicle was shut down last time.

### Display interface description

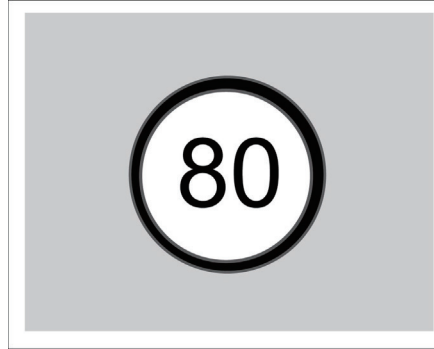

It indicates that ordinary speed limit is recognized, including but not limited to general speed limit sign, combined speed limit sign, lane-dividing speed limit sign, electronic eye speed limit, and interval speed limit.

When the actual speed of the vehicle is slightly greater than the speed limit indicated on the instrument cluster, the speed limit sign on the instrument cluster will flash continuously.

### Activating/deactivating speed alarm sound

The electronic eye speed audible alarm function can be turned on or off in the AV system "Settings → ADiGO intelligent driving → ADiGO active safety assistance → Electronic eye speed audible alarm".

After this function is turned on, when the actual vehicle speed is slightly greater than the speed limit indicated on the instrument cluster and the current road has a speed electronic eye, the speed limit sign indicated on the instrument cluster will flash for a period of time, and an over-speed warning tone will be issued to remind the driver.

The system has an on/off status memory function, and after the vehicle is started, the on/off state will be the same as it was set when the vehicle was shut down last time.

## 5. Driving guide

---

### Function limitations

Even if the TSR is turned on and working, it may incorrectly or fail to detect the speed limit sign due to unavoidable environmental factors and conditions. The system may become affected or inoperative under the following conditions:

- The IFC is blocked or interfered with bright light.
- At night or in the tunnel with weak light, the headlamp is not turned on or the headlamp cannot fully illuminate the speed limit sign.
- The speed limit sign is partially or completely obscured.
- The speed limit sign is worn, blurred or stained.
- The speed limit sign is not properly placed, such as twisted and tilted.
- The speed limit sign is obstructed by the vehicles in the adjacent lane or obstacles.
- The speed limit has been changed due to temporary road construction.
- Navigation data is not updated online in time or inaccurate.
- The road is not standardized, and other road signs are misidentified as speed limit signs.

- Inaccurate navigation and positioning results in the output of non-local road speed limit information.

### WARNING

- **The TSR function can only recognize the speed-related signs, not other road signs.**
- **The TSR can only identify the maximum speed limit of the road. Do not rely on the TSR to determine the appropriate driving speed. Always drive within the safe speed range according to the speed limit and road conditions.**
- **The TSR can only work under some conditions. The driver shall always assume the ultimate responsibility for safe driving and comply with applicable laws and road traffic rules.**

### 5.4.5 Intelligent speed limiter adaptive cruise control (ISL-ACC)\*

The intelligent speed limiter adaptive cruise control is abbreviated as ISL-ACC. When there is speed limit sign on the front path, ISL-ACC will send out the prompt of target vehicle speed synchronization through the information of TSR, and the driver will choose whether to synchronize the target vehicle speed.

#### On and off

Turn on or off the intelligent speed limit control through the AV system “Setting→ADiGO smart driving →ADiGO active safety assist → Intelligent speed limit control” interface.

After this function is turned on, the TSR function is turned on synchronously; After this function is turned off, the TSR function remains in the previous state.

### **i** NOTE

The system has on/off status memory function. After the vehicle is started, the on/off state will be the same as it was set when the vehicle was shut down last time.

### ISL-ACC trigger requirements

To trigger the ISL-ACC, the following requirements shall be met:

- ISL-ACC is on.
- ACC is in working state.
- ACC current target vehicle speed-TSR vehicle speed is greater than the set system difference.
- TSR first recognizes the speed limit sign or recognizes that the speed of speed limit sign changes.

After the ISL-ACC is triggered, the driver will be prompted whether to synchronize the TSR within the next 5 seconds.

### ISL-ACC synchronized target cruising speed

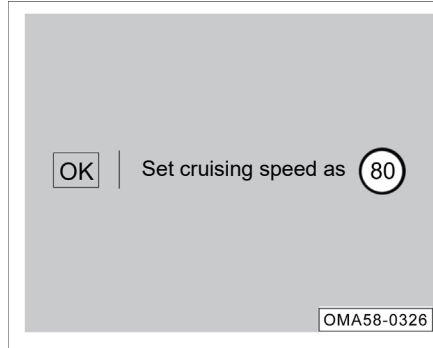

When the pop-up text prompts "Cruising speed set to", "Current speed limit sign" and "OK" appear on the instrument panel:

1. When the driver presses the OK button, it indicates that the driver agrees with the synchronization of speed limit sign, and the ACC target vehicle speed is set to the speed of the current speed limit sign.
2. When the driver does not operate the OK button after approximately 5 s of the prompt message, it indicates that the driver does not use the synchronization of speed limit sign, and the ACC target vehicle speed remains unchanged.

### 5.4.6 Lane departure warning (LDW)\*

LDW is designed to reduce the accidents caused by unintentional lane departure.

The LDW detects the lane marking on the road through the IFC installed on the front windshield, analyzes the driver's driving behavior and vehicle motion state, and issues the warning or intervenes in the steering wheel to correct the deviation when the vehicle unintentionally deviates from the lane due to fatigue, distraction or phone calls. It usually issues the warning or intervenes in the steering wheel when the front wheels cross the lane marking.

When the driver selects the "Steering" or "Steering and warning" mode and the LDW operating conditions are met, the system will monitor the torque on the steering wheel. When the driver's hands are off the steering wheel for a long time, the system will give an alarm to the driver.

## 5. Driving guide

---

### On and off

In the AV system “Settings → ADiGO intelligent driving → ADiGO active safety assistance → LKA”, click  the right soft key of “LKA” to turn on or off the LKA.

When the function is turned on, you can see that the button changes to the on state and the LDW indicator lamp  on the instrument cluster lights up; When the function is turned off, you can see that the button changes to the off state and the LDW indicator lamp on the instrument cluster goes out.

The system has an on/off status memory function, and after the vehicle is started, the on/off state will be the same as it was set when the vehicle was shut down last time.

### Select LKA mode

When the vehicle power switch is in the “ON” position, enter the AV system “Settings → ADiGO intelligent driving → ADiGO active safety assistance → LKA” function to select the LKA mode.

1. Steering
  - When “Steering” is selected, the system only intervenes in the steering wheel for lane keeping assist.
2. Warning
  - When “Warning” is selected, the system only issues a warning.
3. Steering and warning
  - When “Steering and warning” is selected, the system not only issues a warning, but also intervenes the steering wheel for lane keeping assist.

### NOTE

The system has a LKA mode memory function. After the vehicle is started, the LKA mode will be the same as that it was set when the vehicle was shut down last time.

### Warning prompt

The LDW warning prompt is only triggered in the “Warning” or “Steering and warning” mode.

- When the vehicle speed is greater than 65 km/h and the system detects at least one valid lane marking on one side, the instrument cluster status indicator lamp  lights up in blue. It indicates that the system may issue a LDW at this time. When only lane marking on one side is recognized, the system will only alarm for that side.

When the indicator lamp  is blue, if the vehicle deviates from the lane under one of the following conditions, the system will not issue an alarm.

- Depress the brake pedal to slow down with a large braking force.
- Turn on the turn signal lamp on the corresponding side.
- Turn on the hazard warning lamp.
- Turn the steering wheel quickly.
- The time from the last alarm is short.
- Continuously cross the lane markings.



When the indicator lamp  is blue, if there is no action mentioned above and the vehicle deviates from the lane (for example, the driver accidentally deviates from the lane due to fatigue, distraction, or making a phone call), the system will send a warning to the driver, and the corresponding lane marking (red) will be displayed on the instrument cluster, accompanied by a buzzer.

### Steering assist

The LKA prompt is only triggered in the “Steering” or “Steering and Warning” mode.

When the instrument cluster shows that the vehicle speed is greater than 65 km/h and the system detects at least one valid lane marking on one side, the instrument cluster indicator lamp  lights up in blue. It indicates that the system may intervene in the steering wheel for lane keeping assist at this time. When the lane edge of only one side is identified, the system will only correct this side.

When the indicator lamp  is blue, if the vehicle deviates from the lane under one of the following conditions, the system will not intervene in the steering wheel for lane keeping assist.

- Depress the brake pedal to slow down with a large braking force.
- Turn on the turn signal lamp on the corresponding side.

- Turn on the hazard warning lamp.
- Turn the steering wheel quickly.
- The time from the last alarm is short.
- Continuously cross the lane markings.
- The instrument panel prompts the driver to take over if the driver’s hands are off for a long time.

When the system intervenes in the steering wheel for lane keeping assist, the driver can feel the torque exerted by the system on the steering wheel, and the instrument cluster displays the corresponding lane marking (blue) prompt.

### Hands-on reminder



When the LDW detects that the driver’s hands have been off the steering wheel for a long time, the system will issue hands-on reminder and the instrument cluster will display the above figure, accompanied by audible alarm. This prompt only exists when the driver selects “Steering” or “Steering and warning”.

The driver shall immediately hold the steering wheel immediately after receiving the hands-on reminder. Do not panic and avoid turning the steering wheel unnecessarily. When the LDW detects the hand torque applied to the steering wheel, the driver’s hand on the steering wheel can be recognized and the hands-on reminder will be canceled. The LDW is automatically reactivated.

## 5. Driving guide

---

### **i** NOTE

The system may misjudge the driver's hands off the steering wheel when the driver's hands are lightly holding on the steering wheel. In this case, when the system sends a steering wheel hands-on reminder, the driver only needs to hold the steering wheel slightly or shake the steering wheel slightly, the system can detect the torque on the steering wheel, and the hands-on reminder will be canceled.

### **Other tips**

When the system detects that the IFC is inoperative, a "MRR blocked" message will pop up in the instrument cluster.

Usually, this is due to dirty front windshield or IFC exposed to low sunlight. The LDW will not be damaged, and inspection and repair is not necessary.

The driver can try to wipe the front windshield with water spray.

When the system detects a fault, the message "Please check the LDW" will pop up in the instrument cluster, and the indicator lamp will light up in yellow.  Please go to the GAC Motor authorized shop for inspection and repair as soon as possible.

### **Function limitations**

Even if the LDW is turned on and working, it may incorrectly or fail to detect the lane markings due to unavoidable environmental factors and conditions. The system may become affected or inoperative under the following conditions:

- Poor line of sight, such as snow, rain, fog or water spots.
- Dirt, fog on the front windshield or obstruction in front of the IFC on the front windshield.
- Too high temperature around the IFC due to direct sunlight.
- Glare due to direct sunlight, oncoming traffic, reflected light from road water-logging, etc.
- Sudden changes in outdoor brightness, such as entering/exiting tunnels.
- Failure to turn on headlamps at night or when the light is weak in the tunnel.
- No lane marking, or difficulty in distinguishing the lane marking color from the road surface color.
- Unobvious, too thin, worn, blurred or dirt/snow-covered lane markings.
- Too wide or narrow lanes.
- Increased or decreased number of lanes, or complicated lane markings.
- More than two lane markings on the left and right sides of the vehicle.
- Marks or objects similar to lane markings on roads.
- Isolation strips or other objects casting shadows on lane markings.
- Short-term change of marking, such as ramp or highway exit.
- Driving on steep slopes or curved roads.
- Close distance from the vehicle ahead or lane markings blocked by the vehicle ahead.
- Vehicle severely shaken.

The performance of the system intervening in the steering wheel for the corrective assistance may be affected in the following situations:

- The vehicle is overloaded.
- The tire pressure is abnormal.
- The road is uneven.
- There is strong crosswind.
- The driver modifies the parts related to vehicle control.
- The parts related to vehicle control are replaced with non-genuine parts.
- The parts related to vehicle control are improperly assembled.

### NOTE

When the LDW intervenes in the steering wheel, the driver can still turn the steering wheel to control the vehicle. When the torque applied by the system is found improper, the driver can control the vehicle to travel according to his intention when required.

### CAUTION

- When the LDW detects an unintentional departure from the lane, it will issue a warning or intervene in the steering wheel for lane keeping assist. Neither panic nor turn the steering wheel fiercely.
- When the LDW detects that the driver's hands are off the steering wheel for a long time, it will issue a warning. Do not panic, turn the steering wheel fiercely, or shake the steering wheel unnecessarily. The driver should keep holding the steering wheel tightly with both hands for normal driving.
- When you select the LKA mode as "Warning", the system will not issue steering intervention and hands-on reminder, and when you select "Steering", the system will not issue the warning prompt.

### WARNING

- **The LDW is only an auxiliary system and cannot actively control the vehicle to change lanes or keep lanes. The driver has the responsibility to always pay attention to the road conditions and actively control the vehicle. Please always hold the steering wheel and actively control the vehicle.**
- **The improper use or negligence of LDW may cause accidents. Do not rely on LDW or try to drive dangerously with the help of LDW.**

## 5. Driving guide

---



### WARNING

- The LDW does not always recognize lane markings or lane edges. Due to bad weather, poor night lighting, accumulated water and snow on the road surface, broken or blurred lane markings, shadows cast on the road surface, etc., lane markings or lane edges may be missed or misidentified.
- This may cause missed and false triggering of the function, so the driver must concentrate on observing the road and traffic conditions and drive carefully.



### WARNING

- Avoid strong impact, moisture and heat to the IFC, and prohibit disassembling and assembling the parts by yourself. Do not place objects that reflect light on the instrument panel, because these objects are not only easy to dazzle the driver, but also may reflect light into the IFC field of view of the system, affecting the normal operation of the function.
- Do not color the front windshield of the vehicle or add coatings that do not conform to the specifications. Any additional items that affect the detection range of the IFC may affect the normal operation of the system.
- Be aware that the bumper or body shall be avoided from crashing or refitting, otherwise they may affect the normal operation of LDW.



### WARNING

- When the system cannot detect the lane marking, it is judged that the driver intentionally deviates from the lane (such as detecting a fast steering wheel rotation) or the vehicle speed is less than 65 km/h, etc., even if the vehicle deviates from or leaves the lane, the system will not issue the warning or perform the steering intervention.
- The system can only use limited steering ability, so it cannot guarantee that the vehicle will be corrected back to the lane under any circumstances.
- The sound inside the vehicle or the noise outside the vehicle may prevent you from hearing the warning buzzer, so it cannot guarantee that you will be reminded of the LDW under any circumstances.

### 5.4.7 Intelligent headlamp control (IHC)\*

The IHC system detects traffic and environmental factors in real time through a IFC sensor on the upper edge of the front windshield, and automatically switches between low beam and high beam. For example, when driving on a road with insufficient lighting at night, if the driver turns on the IHC function and the system judges that the high beam turning on conditions are met, the high beam will be automatically turned on; When the system recognizes an oncoming vehicle or a vehicle ahead is too close, it will automatically switch from high beam to low beam.

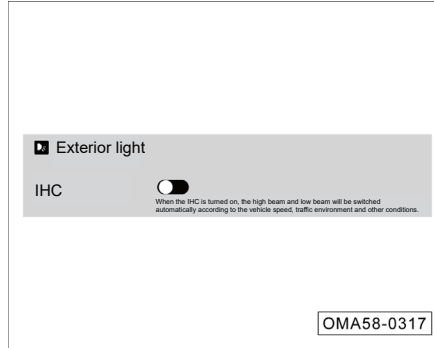

#### Activating IHC



1. When the vehicle power is in the "ON" position, in the AV system "Settings → Body accessories → Exterior light → IHC", click  the soft key on the right side of "IHC" to turn on the IHC.

#### NOTE

This has a memory function. After the vehicle is started, the on/off state will be the same as it was set when the vehicle was shut down last time.

2. Turn on the IHC by setting the lamplight switch to the AUTO position.
  - After the IHC function is turned on, it is in the standby state. When conditions for turning on the high beam are not met, or the driver does not manually turn on the high beam, the instrument cluster indicator lamp  will be in white.
  - After the IHC function is turned on, if the conditions for turning on the high beam are met, the system will automatically switch to the high beam, and the instrument cluster indicator lamp  will be in blue.

#### Deactivating IHC

The IHC function is turned off when one of the following conditions is met:

- The lamplight switch is set to a position other than AUTO.
- The IHC is turned off in the AV system "Settings → Body accessories → Exterior light → IHC", and by clicking  the IHC soft key on the right.
- The vehicle is flamed out.

## 5. Driving guide

### NOTE

The high beam and high beam flash functions can be manually turned on/off at any time.

### Disabling conditions of IHC

In the following cases, the high beam request will be suppressed and the IHC system will request to turn off the high beam:

- The vehicle speed value is lower than 15 km/h.
- The fog lamps are turned on or it is rainy or foggy weather.
- The wiper is turned on to HI position for a period of time.
- The ambient light is bright.
- The street lamp, vehicle ahead in the short distance or an oncoming vehicle is detected.

The IHC system will be deactivated in the following cases. In the absence of the conditions mentioned above, the system will propose to maintain the current light state:

- Too high lateral acceleration or yaw velocity.
- High dynamic state (ABS or ESP activated).
- The vehicle speed value is lower than 35 km/h.

- The turn signal lamp is turned on.

### Function limitations

The IHC function may not function in time or even be inoperative due to the following reasons:

- The surface of the windshield in front of the IFC is covered by ice and snow, fog, dirt, stickers or other attachments.
- There is highly reflective object on a low-lit street.
- The vehicle encounters pedestrians or bicycles, etc. on a road or a roadside with poor lighting.
- The light of the front oncoming vehicle is blocked by a crash barrier, a high bow-top road fence, a green belt, etc.
- The brightness of the tail lamps of the vehicle ahead is low or does not comply with national standards when the vehicle is following the vehicle ahead.
- The vehicle encounters another half-covered incoming vehicle in case of sharp turns/mountain roads/low-lying ground.
- The vehicle is driving on a slope or a bumpy road.
- The vehicle is driving in a heavily rainy, snowy or foggy day.

- The IFC is damaged or the power supply is interrupted.

### WARNING

**IHC is a driving assistance function which helps you to select the best lighting way when conditions are right. Under all traffic conditions and environmental conditions, the driver is always responsible for manually switching the high beam and low beam.**

- **The IHC may not be able to correctly identify all driving environments and cannot work normally in some environments.**
- **If the IFC is blocked by dirt, stickers, snow, etc., the IHC may not work.**

### WARNING

- If the vehicle lighting system is changed (for example, the headlamp is modified), the IHC performance may be degraded or the function may not be available.
- In the case of oncoming non-motor vehicles such as bicycles and electric bicycles or pedestrians, the IHC system shall be turned off in time to prevent dazzling.

### 5.4.8 Radar and IFC sensor\*

#### MMW radar sensor

The MMW radar sensor is installed in the middle of the front bumper lower grille to monitor traffic conditions and detect vehicle ahead within a certain range from the vehicle.

The radar sensor must be adjusted and calibrated under the following conditions:

- The mounting bracket of the MMW radar sensor has been removed and installed.
- The MMW radar sensor has been removed and installed.
- Toe or rear wheel camber has been adjusted during four-wheel alignment.
- After a vehicle collision.

### NOTE

- The adjustment and calibration of the MMW radar sensor requires the use of specific special tools and equipment. If you need to adjust and calibrate the MMW radar sensor, please be sure to go to the GAC Motor authorized shop for related work.
- When the MMW radar sensor fails or is misadjusted, it may affect the ACC, ICA or FCM.

#### Special instructions for MMW radar sensor

The MMW radar sensor is installed at the front of the vehicle, and no obstacle is allowed within the detection range of the MMW radar sensor. Do not install license plate frame or other obstacles when installing the front license plate. Otherwise, the detection performance of the MMW radar sensor will be affected, resulting in the failure of the ACC, ICA or FCM.

## 5. Driving guide

### CAUTION

- If the MMW radar sensor is dirty, blocked by the license plate frame, or covered by any foreign matter such as heavy rain, ice, snow, mud, the related functions of the radar sensor may not work and the instrument cluster will give disable/fault indication for these functions. To restore these functions to normal, clean the dirt and/or foreign matters.
- When there is a strong reflection on the MMW radar ultrasonic wave (e. g. in parking lot), the related functions of the MMW radar sensor may be affected.
- It is prohibited to paste or add stickers, driving assistant lights, license plate frames or other similar objects in front of and around the MMW radar; otherwise it may affect the relevant functions of the MMW radar sensor.
- It is recommended to use a brush to remove snow from the sensor surface; It is recommended to use an insoluble de-icer spray to remove ice from the sensor surface.

### CAUTION

- Maintenance of the front body of the vehicle may cause change in the radar sensor direction and affect related functions of MMW radar (ACC/ICA/FCM). Therefore, please go to the GAC Motor authorized shop for repair in time.
- If the MMW radar sensor is damaged or the direction changes, please turn off MMW radar related functions (ACC/ICA/FCM, etc.) and go to the GAC Motor authorized shop in time to recalibrate the MMW radar sensor.
- The direction of the MMW radar sensor may change due to vibration, for example, the part near the front bumper radar collides with the roadside/flower bed. Change of the direction of the sensor may affect the performance of the functions dependent on the radar or even cause abnormal deactivation of these functions.

### IFC

A IFC is installed on the upper part of the front windshield to detect the surrounding environment. The maximum recognition distance for barrier-free pedestrians can reach 80 m (ideal for environmental factors such as lighting), and the minimum pedestrian detection height of the camera is 0.8 m.

The IFC sensor must be calibrated under the following conditions:

- The front windshield or camera bracket is removed and replaced.
- The IFC sensor is removed and replaced.

### NOTE

If the IFC fails, the ACC, ICA, LDW, FCW and IHC will fail as well.



### NOTE

- The calibration of IFC sensors requires the use of specific special tools and equipment. If it is necessary to calibrate the IFC sensor, it is recommended to go to the GAC Motor authorized shop for related work.
- When the IFC sensor fails, malfunctions or is blocked, it may affect the normal use of the ACC, FCM, LDW, ICA, IHC and other functions.

### CAUTION

Poor lighting conditions, nighttime, backlighting, rainstorm, water mist, ice and snow or sludge may affect the IFC, resulting in interruption or performance degradation of the FCM, ACC, ICA, AEB, LDW and IHC, and in severe cases, resulting in complete deactivation of functions. At that time, the instrument cluster will prompt the intelligent driving assistance warning information such as "MRR blocked", "IFC blocked", "Please check LKA", "Please check ACC", "Please check FCM", etc.

### CAUTION

The vision of the IFC may be affected by obstruction such as dust, sediment, water mist, ice, snow or sludge on the front windshield. In these cases, the functions of the LDW, FCM, ACC, ICA and IHC will be deactivated. Please wipe the area near the IFC on the front windshield, or turn on the defroster and defogger functions of the A/C. After the obstruction is removed, the function can be restored.

## 5. Driving guide

### CAUTION

- If the IFC interference factor disappears, the PDS function will work normally again.
- Low light conditions at sunset or night may affect the functioning of PDS. Never block the view around the IFC with stickers or opaque objects; otherwise, the pedestrian detection function may not work properly.
- Please confirm whether there is any obstruction in the IFC area before driving the vehicle.
- Keep a clear view of the IFC sensor on the front windshield.

### 5.4.9 Tire pressure monitoring system (TPMS)

The system monitors the pressure and temperature information of the tire via the tire pressure sensor mounted on the rim, and sends the tire information to the receiver (BCM) via the wireless transmitter. The receiver receives, decodes and analyzes the received wireless signal, and sends it to the instrument cluster via the bus to display the current tire pressure and temperature information. When the tire has abnormal conditions such as low pressure, high pressure, rapid air leakage and high temperature, the receiver will send out an alarm signal and display it on the instrument cluster.

If the vehicle has been stationary for more than 7 days or the battery has been disconnected, when the vehicle power is switched to the "ON" position, the tire pressure and temperature values on the instrument cluster will be displayed as "---". After the vehicle speed exceeds 25 km/h for several minutes, the current tire pressure and temperature values will be displayed on the instrument cluster.

#### Alarm description

- If the tire pressure value is higher than 330 kPa, the TPMS indicator lamp lights up, and a warning message on the instrument cluster display shows that the tire pressure is high; When the tire pressure value is lower than 300 kPa, the fault is eliminated and the TPMS indicator lamp goes out.
- If the tire pressure value is lower than 75% of the normal set value, the TPMS indicator lamp lights up, and a warning message on the instrument cluster display shows that the tire pressure is low; When the tire pressure (in cold state) value is normal after inflation, the fault is eliminated and the TPMS indicator lamp goes out.
- If the tire pressure value continues to decrease by more than 30 kPa/min, the TPMS indicator lamp lights up, and a warning message on the instrument cluster display shows tire leakage; When the vehicle is powered on again, the fault is eliminated, and the TPMS indicator lamp goes out.
- If the tire temperature value is higher than 85°C, the TPMS indicator lamp lights up, and a warning message on the instrument cluster display shows high tire temperature; When the tire temperature drops to 80°C, the fault is eliminated and the TPMS indicator lamp goes out.

### NOTE

After the spare tire is installed or the tire is replaced at another place, the low tire pressure warning will not disappear when the vehicle keeps running as the tire pressure sensor is absent. This does not mean that the tire pressure is abnormal.

### CAUTION

After the tire pressure sensor is replaced or the tires are rotated, there is no need to go to the Gac Trumpchi Special Shop for calibration learning again if a tire pressure sensor suitable for the vehicle model has been properly installed. The tire pressure monitoring system will finish calibration learning automatically in the following driving cycles.

## 5. Driving guide

---

### 5.5 Parking assist systems

#### 5.5.1 Rear parking assist (RPA)

The RPA uses the radar sensor to send and receive the ultrasonic waves reflected from the obstacle so as to measure the distance between the vehicle and the obstacle.

##### On and off

- Release the EPB of the vehicle, and set the gearshift lever to "R" gear. When the reverse speed is less than 10 km/h, the RPA will start to work.
- When the vehicle speed is more than 12 km/h or the gearshift lever is in the "R" gear, if the EPB is applied, the RPA will exit.

##### Dynamic view \*



The dynamic view on the display indicates the distance between the current vehicle and the obstacle. In the figure, the outermost layer of the vehicle is the green line, gradually yellow line, orange line and red line inwardly. When the obstacle is getting closer to the vehicle, the color line will gradually change from the outermost layer to the inner layer.

The change of the dynamic view is synchronized with that of the distance audible alarm.

Obstacle detection distance			Audible alarm
Rear left sensor	Rear right sensor	Rear middle sensor	
90~120cm	90~120 cm	90~150cm	No audible alarm
60~90 cm	60~90 cm	60~90 cm	Intermittent slow audible alarm
30~60 cm	30~60 cm	30~60 cm	Intermittent quick audible alarm
Within 30 cm	Within 30 cm	Within 30 cm	Continuous audible alarm

### **Audible alarm with reference to distance**

The audible alarm changes with the distance between the obstacle and the rear bumper, and the color on the AV system display also changes accordingly. If the vehicle approaches the obstacle, the system will give an audible alarm. The closer the vehicle is to the obstacle, the shorter the alarm sounds; The system will send a continuous alarm when there is a very close obstacle near the vehicle. If the vehicle continues to approach the obstacle at this time, the system will no longer be able to detect the obstacle.

## 5. Driving guide

### Distribution of RPA sensors

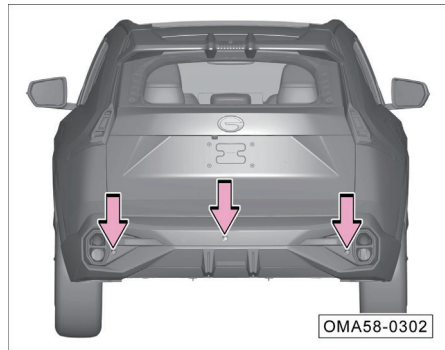

The radar sensor is mounted on the rear bumper cover.

#### CAUTION

- Always keep the surface of radar sensor clean and do not cover the radar sensor.
- To ensure the function of the radar sensor, it should be kept clean and free from ice.
- When cleaning the radar sensor surface, use a soft wet cloth to avoid scratching the surface.

#### WARNING

- **The RPA cannot replace the driver's observation of the surrounding environment. The driver should concentrate and reverse the vehicle safely according to the actual situation.**
- **The radar sensor has a blind spot when detecting obstacles. When reversing, the driver must pay attention to observing to avoid accidents.**
- **When reversing in a narrow place or uphill, the radar sensor may not detect railings, trees, or slope surfaces, which is normal.**
- **When the reversing speed is fast, the detection accuracy of the radar sensor will decrease. It is recommended that the speed should not exceed 10 km/h. When the RPA sends the continuous alarm, the vehicle is very close to the obstacle at this time. Stop reversing immediately to prevent accidents.**

### WARNING

- When cleaning the radar sensor with the high-pressure cleaner, it shall be short-time and gentle, and the distance between the nozzle and the sensor shall be at least 30 cm.
- If water droplets are attached to the surface of the radar sensor, the sensitivity of the sensor will decrease. Just wipe off the water droplets attached to the sensor to restore its sensitivity.
- The surface of some subjects may not reflect the signal from the radar sensor, so the radar sensor cannot detect such subjects or people wearing such clothing.
- Noise sources outside the vehicle may interfere with the radar sensor, preventing it from detecting any target.
- The radar sensor is a precision component. Do not disassemble or repair it without permission. The Company will not assume quality guarantee for any damage caused by unauthorized disassembly and maintenance.

### 5.5.2 Reverse image system\*

The reverse image system can provide 130° wide-angle video, and can display a wide range of rear video images on the AV system display, allowing the driver to master various complex road conditions behind the vehicle and improving reversing safety.

#### On and off

When the vehicle power is in the “ON” position and the gear is shifted to the “R” position, the reverse image system will automatically start to work, and the AV system display will start to display the rear image and the distance reference lines.

When the gear is shifted out of “R” position, the reverse image system will exit and the AV system will exit the reverse image display.

### WARNING

**The reverse image system cannot replace the driver’s observation of the surrounding environment. The driver should concentrate and reverse the vehicle safely according to the actual situation.**

### Dynamic trajectory

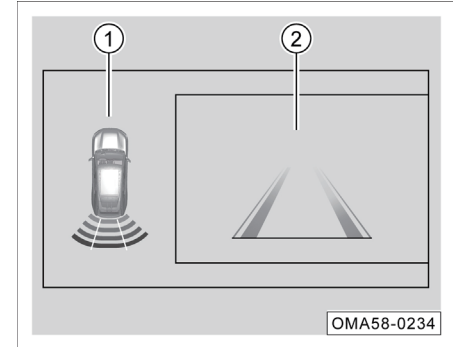

The display shows the wheel trajectory and the body driving trajectory:

- ① Reverse radar display area
- ② Reverse image display area

## 5. Driving guide

### CAUTION

The above trajectory is the reference distance obtained by testing on flat ground and is only used as a reference for judging visual distance. In case of driving on a slope, the above distances cannot be used as accurate references.

### NOTE

- The longitudinal lines on both sides of the distance reference line can be used as the reference line for judging the required parking space size when reversing or parking.
- The distanced reference lines can be adjusted constantly as the steering wheel is turned.

### CCD

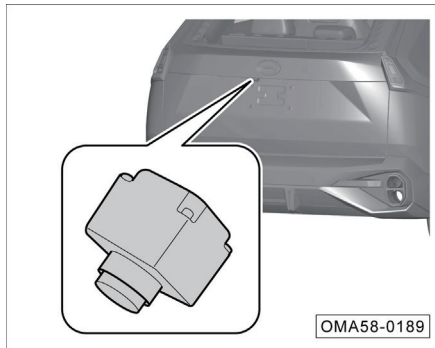

The CCD is installed next to the license plate lamp.

### WARNING

- **The CCD have blind spots, for example, it may not detect young children or small pets. Therefore, the driver is required to pay special attention to the young children or small pets around the vehicle during reversing.**
- **The CCD may also not be able to recognize the vertical objects at higher position, such as wall flange.**

### CAUTION

- Always keep the CCD surface clean. When cleaning the CCD, always use a piece of soft damp cloth to avoid scratching.
- Do not wash the CCD with high-pressure cleaner for a long time, and keep a distance of at least 30 cm from the CCD during cleaning.
- Do not cover the CCD.



### 5.5.3 Around view monitor (AVM)\*

The AVM can provide the driver with vehicle surrounding environment information through real-time images to reduce driving blind spot. It can also predict the vehicle movement trajectory in combination with parameters such as steering wheel angle and vehicle size, and superimpose it on the panoramic image, so that the driver can fully understand the direction of the vehicle and judge whether it is safe to reverse.

The AVM consists of four cameras, AV system display screen, and "AVM" APP on the AV system. By collecting the images of the front, rear, left and right directions of the vehicle, and stitching them into a 360° bird's-eye view around the vehicle through image processing algorithm, the AVM displays the view on the AV system.

#### On and off

1. The AVM can be turned on and off by the gearshift lever. When the vehicle power switch is in "ON" position:
  - When the gear is shifted to "R" position, the AVM will automatically turn on the full-screen 2D rear view.
  - When the gear is shifted out of "R" position and the driver has no relevant operation, the AVM will automatically exit after about 30 s by default.
2. The AVM can be turned on and off by pressing the AVM button or voice. When the vehicle power switch is in "ON" position:
  - Click the AV system menu bar  icon to enter the application menu interface, and click the "AVM" icon to turn on the AVM system; Click the "Exit" soft key in the panoramic interface to exit the AVM system.
3. Turn on and off by "left/right steering lever". When the vehicle power is in the "ON" position:
  - Toggle the "left/right steering lever" to the "left" or "right" position to turn on the AVM; Toggle the "left/right steering lever" to the "middle" position to turn off the AVM.

- This function can be set "On" or "Off" in the "Settings" item of the panoramic view ".

## 5. Driving guide

### Interface description

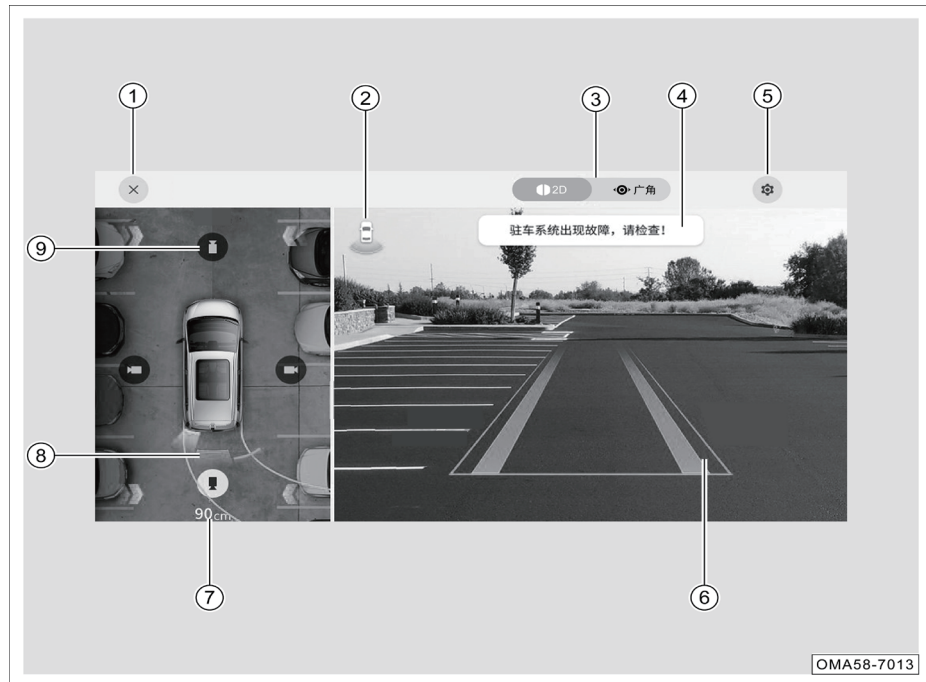

- ① Exit soft key
- ② Current view direction
- ③ 2D/3D/wide angle view switching soft key
- ④ Message pop-up window
- ⑤ Setting
- ⑥ Trajectory
- ⑦ Radar distance display
- ⑧ Radar detection area
- ⑨ Soft key for view direction switch

#### **i** NOTE

The interface and function buttons of the AVM display differs depending on the vehicle configurations. Please refer to the actual vehicle.

### Settings of AVM

#### 1. Trajectory

- The trajectory is displayed in the top view and 2D view after the trajectory switch is turned on, and the trajectory is not displayed in the top view and 2D view after the trajectory switch is turned off.
- This function can be set “On” or “Off” in the “Settings” item of the panoramic view “.

#### 2. P gear exit

- When the P gear exit switch is set as “immediate”, the panoramic view will be exited immediately after the gear is shifted to P gear; When the P gear exit switch is set as “after 30 s”, the panoramic view will be exited after the gear is shifted to P gear for 30 s.
- This function can be set “On” or “Off” in the “Settings” item of the panoramic view (there will be differences under multiple panoramic display conditions, subject to the actual vehicle).

#### 3. Panoramic view activation via turn signal lamp

- When the turn signal lamp-panoramic view activation switch is turned on, if the vehicle speed is within 20 km/h and the left/right turn signal lamp switch is turned on, the panoramic 2D left/right view will be displayed, and if the left/right turn signal lamp switch returns, the panoramic view will exit.
- This function can be set “On” or “Off” in the “Settings” item of the panoramic view.

### i NOTE

- When the AVM is turned on, the AV system will start to display the images taken around the vehicle, and some auxiliary lines and radar prompt information will be displayed on the images.
- The system will automatically switch off if the forward speed of the vehicle is greater than 20 km/h.
- The system will automatically switch off when the vehicle is in non-“R”gear and the system is activated for more than 30 seconds.
- If the AV system is not completely activated, the system cannot function properly.

## 5. Driving guide

### i NOTE

- When gearshift lever is in the “R” gear, the image display defaults to single 2D rear view.
- When gearshift lever is in the “R” gear, the image display defaults to single 2D rear view.
- The 2D and 3D modes are memorized (except for the defaulted 2D rear view in R gear), while the wide angle view is not memorized. If it is in 2D mode before exiting the AVM, it will be in 2D mode by default when you enter next time.
- The message pop-up window is only displayed when there is a message, and not displayed at other times.

### i NOTE

- On the wide angle interface, you can view different camera views of “front wide angle”, “rear wide angle”, “front wheel” and “rear wheel”.
- When the left turn signal lamp is turned on, the image display switches to single 2D left view; when the right turn signal lamp is turned on, the image display switches to single 2D right view;
- The user can manually switch the view via the “view” soft key, and the image display shows the corresponding view.

### Camera distribution

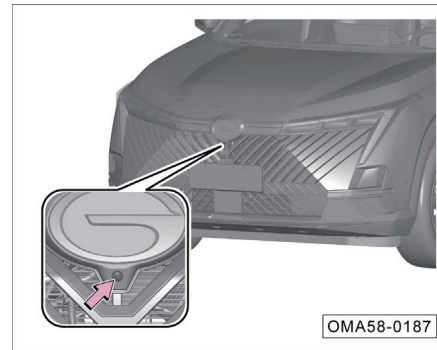

The front camera is installed under the front logo.

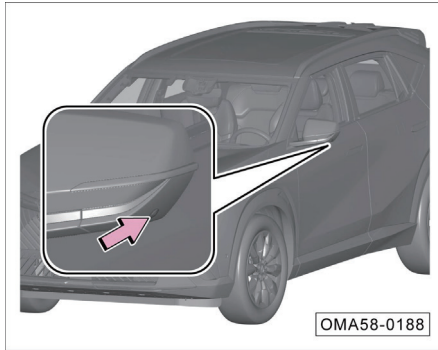

The left/right camera is installed on the left/right exterior rearview mirror respectively.

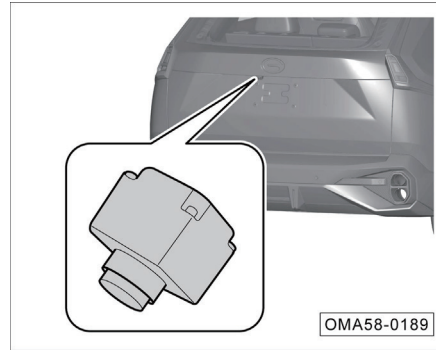

The CCD is installed next to the license plate lamp.

### **i** NOTE

To ensure the normal operation of the camera:

- Please keep the camera surface clean and free of ice, snow, accumulated water, dust and other foreign objects.
- When foreign matters are found on the surface of the camera, please wipe them with a soft cloth or clean with water (at low water pressure), and keep a distance of at least 30 cm from the camera during cleaning.
- Do not use high-pressure cleaner or abrasive or sharp objects to clean the camera.

## 5. Driving guide

### CAUTION

Functional limitations:

- When the camera fails to work normally, the function that relies on the camera to provide identification information will be limited. The identification range of the camera is limited, and it is impossible to identify the target beyond the identification limit.
- When the external environment is poor, resulting in unclear view of the camera, it will affect the recognition ability of the camera.

### CAUTION

The following conditions can cause the camera failure to identify the target, delay in identification, or incorrect identification:

- Poor lighting conditions (dim, low light) or poor visibility (caused by heavy rain, snow, dense fog, etc.).
- Camera facing light source direction or insufficient light intensity.
- Sharp changes in light (such as entering and exiting tunnels).
- Weather conditions (heavy rain, snow, fog, extremely hot or extremely cold temperature).
- Camera surface attached with ice, snow, frost, rain, fog, water, dust and other foreign objects.
- Vehicle bumps or shakes due to uneven road.
- Camera view blocked.

The above examples, warnings, and limitations do not cover all the conditions that affect the normal operation of the camera sensor.

### WARNING

- **The camera is only for auxiliary use, and the camera cannot work normally under all driving, traffic, weather and road conditions. When the vehicle is in a complex or poor environment, drive carefully and always be responsible for driving safety.**
- **No license plate frame or other objects can be installed on the front and rear license plates to avoid interference with sensors such as camera and radar.**
- **It is forbidden to replace, refit or add camera without permission, and only the original or approved GAC Motor Co., Ltd. camera can be used. Otherwise, the relevant functions may not be used normally, and the GAC Motor Co., Ltd. will not bear any responsibility for the direct or indirect losses caused thereby.**

### 5.6 Electric power steering (EPS)

The EPS is a power steering system that directly relies on the motor to provide auxiliary torque. It is mainly composed of integrated torque and angle sensor, motor, steering electric control unit (ECU) and reducer.

The EPS ECU controls the motor assist torque output in real time by detecting the driver's torque input, vehicle speed, engine speed and other vehicle status signals, providing the best steering assistance, ensuring the vehicle's low-speed steering agility and high-speed steering stability, and improving driving comfort and vehicle safety.

#### EPS indicator lamp

When the vehicle power is in the "ON" position, the indicator lamp  will light up, and after the self-test is completed, the system indicator lamp will go out, indicating that the EPS works normally.

If the indicator lamp lights up after engine start or during driving, it indicates  that the EPS is faulty, and the instrument cluster display will issue a warning "Please check EPS". In this case, park the vehicle in a safe place, try to shut down the engine and start it again. If the indicator lamp does not go out or it lights up again during driving, do not continue driving. Please contact the GAC Motor authorized shop for inspection and repair in time.

#### Steering mode

The steering mode is divided into "light, comfort and sport" modes. The light mode has light hand force, the comfort mode has moderate hand force, and the sport mode has heavy hand force. The system defaults to "light" mode. When the vehicle is stationary, release the steering wheel, and set the steering mode in the AV system "Application menu-Adaptive vehicle dynamic control-Current mode settings-Steering wheel force".

#### CAUTION

When driving, it is forbidden to set steering mode to prevent accidents.

## 5. Driving guide

---

### 5.7 Driving skills

#### 5.7.1 Pre-driving safety inspection

##### Daily inspection

- Check the tire pressure and tire for cuts, bulges, damage or excessive wear.
- Check whether the wheel bolts are missing or loose.
- Check whether the headlamps, brake lamps, tail lamps, turn signal lamps and other lamps are working properly; Check the beam direction of the headlamp.
- Check that the seat belt is free of wear or damage; After wearing the seat belt, check that the seat belt can be fastened firmly.
- Check that the pedal has enough free stroke.
- Check whether the coolant level, engine oil level, brake fluid level, and windshield washer fluid are normal.
- Check the battery terminal for corrosion or looseness, and the shell for cracks or expansion and deformation.
- Check for leakage of fuel, engine oil, water or other fluids under the vehicle, and pay attention that water drip found after A/C operation is normal.

##### After start/during driving

- Check whether the instrument cluster works properly; Check whether there is indicator lamp, alarm message, etc.
- Check whether all the control units (such as lighting combination switch, wiper combination switch, defroster, etc.) work normally.
- Check and confirm that the vehicle does not deviate to any side during braking on a safe road.
- Check for other anomalies, such as part looseness, leakage and unusual noise.

#### 5.7.2 Driving during running-in period

In order to ensure the service life of the vehicle, the vehicle must be run in at the initial stage of use before it can be put into normal use. When your vehicle is in the run-in period, please observe the following rules:

- The mileage of the run-in period is 1500 km.
- Choose roads in good condition and drive the vehicle at reduced load and limited speed.
- Do not start the engine with full throttle or drive with harsh acceleration.
- Avoid emergency braking within the first 300 km.
- Strictly follow the operating procedures and make sure that the engine has reached normal operating temperature. Do not change the oil before regular maintenance.
- Carry out the daily maintenance of the vehicle carefully. Check and tighten the external bolts and nuts frequently. Pay attention to the sound and temperature changes of each assembly during operation and adjust them timely.



### Engine running-in

The mileage in the running-in period of a new engine shall be 1500km. Do not perform the following operations within 1000 km of the vehicle driving mileage:

- Keep the vehicle speed no more than 3/4 of the maximum allowable speed.
- Do not drive the vehicle with full throttle.
- Avoid running the engine at high speed.
- Do not tow any trailer.

Within the vehicle driving mileage of 1000 km ~ 1500 km, it is allowed to increase the engine & vehicle speeds gradually to the maximum allowable range.

The internal frictional resistance of the engine at the beginning of running-in is much greater than that after running-in, and all the moving parts of the engine can have the best fitting after running-in.

After fully running in, both the service life and the fuel consumption of the engine can be improved.

### Running-in of tire and brake lining

Within the mileage of 500 km, the new vehicle shall be driven at a moderate speed for good running in of new tires.

Within the mileage of 200 km ~ 300 km, the brake lining does not reach the best friction state, so the new vehicle shall be driven at a low speed and emergency braking shall be avoided as much as possible.

#### WARNING

- **New tires and brake lining without running-in do not have the best adhesion and friction. Therefore, it is necessary to drive carefully within the first 500 km for good running-in of tires to prevent accidents.**
- **The new brake lining after replacement must also be subject to run-in in accordance with the above requirements.**
- **When driving vehicle, keep a proper distance from other vehicle to prevent the occurrence of emergency braking, as the new tires and brake lining have not fully run in at this time. If an emergency braking is applied, a traffic accident is likely to occur.**

#### WARNING

- **If the brake is damp, frozen or the vehicle is driven on a salted road, the braking effect will decrease.**
- **The brake shall be applied according to the road and traffic conditions. Do not depress the brake pedal unnecessarily, which will overheat the brake and lead to long braking distance and excessive brake wear.**
- **Do not shut down the engine and allow the vehicle to coast, because when the brake booster doesn't work, the braking distance will increase greatly, easily causing an accident.**

## 5. Driving guide

### 5.7.3 Driving essentials

#### Precautions under various road conditions:

- When driving on roads with crosswinds or gusts, slow down in advance, and control the speed and steering wheel well.
- Avoid driving on sharp objects or other road obstacle, otherwise it may cause serious damage such as tire burst.
- When driving on bumpy roads or uneven roads, reduce the speed and drive at a low speed, otherwise it may scratch the chassis and cause vehicle damage.
- When driving downhill, slow down in advance to avoid emergency braking and overheating or excessive wear of the brake system.
- When driving on a smooth road, be careful when accelerating or braking. Rapid acceleration or emergency braking may cause wheel slip.
- When driving on icy and snowy roads, drive at a low and constant speed and avoid rapid acceleration or emergency braking; The wheels can be fitted with tire chains as required.

#### Precautions while driving over a waterlogged road section:

1. Before driving on a waterlogged road section, check the depth of water, which shall not exceed the lower edge of the body.
2. During wading, turn off the A/C before the vehicle starts, slow down, gently depress and hold the accelerator pedal, and pass through the waterlogged section at a stable and low speed.
3. Do not park the vehicle in the water, or reverse or shut down the engine in the water.
4. After successfully wading through the waterlogged section, gently depress the brake pedal for several times to evaporate the water on the brake discs so as to restore the normal braking performance as soon as possible.

#### **i** NOTE

After vehicle cleaning or driving on deep water road, the brake lining and brake disc are soaked in water, the braking effect will be greatly reduced when the brake is applied; The braking distance will be longer than normal, and the vehicle may be biased to one side, and the parking brake will not be able to brake vehicle firmly. In this case, drive at a low speed first, and gently step on the brake pedal continuously to remove the residual moisture in the brake. After the braking effect returns to normal, drive normally.

#### Driving essentials in winter

1. Check if the coolant is in good condition and if it has good anti-freeze effect as follows:
  - Fill the cooling system with the coolant of the same type as the original one according to the ambient temperature.
  - Adding unsuitable coolant may cause damage to the engine.

2. Check the battery and cable conditions:
  - A low temperature in chilly days will reduce the capacity of battery, and therefore, fully charge the battery for start-up in winter.
3. Prevent the door lock from being frozen by ice and snow as follows:
  - Spray some de-icer spray or glycerin into the door lock hole to prevent the door lock from being frozen.
4. Use detergent containing antifreeze:
  - Such products are available in GAC Motor authorized shop.
  - The mixing ratio of water and antifreeze shall be according to the manufacturer's instructions.
5. Avoid accumulated ice and snow under the mudguard:
  - Accumulated ice and snow beneath the mudguard may result in difficult steering. When driving in the cold winter, stop the vehicle regularly and check whether there is ice and snow under the mudguard.
6. It is recommended to bring some necessary emergency items according to the road conditions, such as:
  - Tire chains, a window scraper, a bag of sand or salt, a flashing light, a plough staff, connecting cables, etc., which are recommended to be placed in the vehicle.
7. In cold winter (especially in northern China), avoid starting the engine frequently and shutting down the engine immediately after a short-time start. If the engine is often in an alternating heat & cold cycle, the condensed water is likely to form in the engine. Condensed water adhering to the engine oil may give an illustration of water-in-oil emulsion. When the engine has been restarted and warmed up, this illustration will disappear; In addition, please change the oil regularly according to the Warranty Manual.

### 5.7.4 Efficient use of vehicle

- Before driving, make sure that the parking brake is completely released and the parking brake indicator lamp goes out.
- Keep sufficient tire pressure. Insufficient tire pressure will cause excessive tire wear and waste fuel.
- The wheel alignment must be accurate, otherwise it will cause too fast tire wear, increase engine load and waste fuel.
- Do not make the vehicle load overweight, but remove unnecessary items from the vehicle. The overweight load increases the engine load and wastes fuel.
- Accelerate the vehicle slowly and smoothly to avoid rapid acceleration.
- Avoid roads with traffic jams as much as possible, as driving in traffic jam will increase the fuel consumption.
- Drive according to traffic lights, or keep a safe distance from other vehicle to avoid unnecessary parking or emergency braking, which can save fuel and reduce brake system wear.

## 5. Driving guide

---

- Do not depress the brake pedal while driving, which will cause premature wear of brake lining, overheating and waste of fuel.
- Select a good road while driving. If driving on uneven road, control the speed to avoid collision or scratch.
- If the vehicle chassis is stained with too much soil and other objects, clean it in time, which not only reduces the dead weight of the vehicle, but also prevents the corrosion.
- Maintain the vehicle regularly to keep it in the best working condition. Dirty air filter, spark plug, oil and grease will reduce the performance of the engine and waste fuel.
- When starting the engine at a low temperature, drive slowly for a few minutes, and ensure the engine is warmed up before acceleration.
- Do not open windows when driving at high speed.
- Properly use the A/C, etc.
- In case of parking for a long time, please shut down the engine to avoid wasting fuel due to long time idling of engine.

### 5.7.5 Fire prevention

In order to prevent vehicle fire, pay attention to the following matters during use:

1. It is forbidden to store flammables or explosives in the vehicle:
  - In the hot summer, the internal temperature of the vehicle parked in the sun can be as high as 70°C. If the lighter, cleaning agent, perfume and other flammables or explosives are stored in the vehicle, it is easy to cause fire and even explosion.
  - The items with fire risk such as lithium battery or power bank stored in the unattended vehicle are also easy to cause fire.
2. Make sure the cigarette butts are completely extinguished after smoking:
  - If the cigarette butts are not completely extinguished, fire may be caused.
3. It is recommended to go to the GAC Motor authorized shop regularly for inspection:
  - Also subject all electric lines of the vehicle to regular inspections. Specifically speaking, check whether the connectors, insulation, and fixing positions of electrical components and harnesses are normal, and handle any problems found during inspection in a timely manner.

4. Never modify the electrical circuits of the vehicle or install additional electrical components:
  - The installation of other electrical consumers (such as high-power AV) may cause excessive load in the circuits, or fire due to overheated harness.
  - Never use fuses that exceed the rated specifications of the electrical consumer or other metal wires to replace the fuses.
5. Driving precautions:
  - During vehicle driving and parking, especially in summer, pay attention to checking whether there are flammable materials under the vehicle, such as hay, dead branches, leaves, straw, etc. As the temperature of engine exhaust pipe and other components rises after the vehicle runs for a long time, if there are flammable materials under the vehicle, they are likely to be ignited, causing a fire.
  - Do not park the vehicle in the garbage dump and other places with serious rat infestation, and do not store articles that are easy to attract rats, such as snacks, because rats will bite the vehicle harness, causing a fire.

6. Keep portable fire extinguisher on the vehicle, and master the use method:
  - In order to ensure the safety of the vehicle, it shall be equipped with fire extinguisher, and shall be inspected and replaced regularly; At the same time, be familiar with the use of fire extinguisher, and be prepared to avoid being helpless in case of accidents.

## 6. Use and maintenance

### 6.1 Maintenance instructions

#### Safety precautions

To avoid potential hazards, please read this section before work and confirm that you have the necessary tools and techniques.

- Confirm that the vehicle is parked on a flat ground, turn off the engine, and apply the parking brake.
- When cleaning parts and components, use the commercially available de-greaser or parts cleaner, instead of gasoline.
- Keep lit cigarettes, sparks and open flames away from the battery and all fuel system related components.
- When carrying out operations related to battery or compressed air, wear goggles and protective clothing.

#### WARNING

**Incorrect vehicle maintenance or driving vehicle before solving the problem may cause traffic accidents, resulting in serious injury or death.**

#### Potential hazards of the vehicle

- Carbon monoxide: carbon monoxide in the exhaust gas of the engine is toxic. Be sure to operate the engine in a well-ventilated place.
- Scalding: the engine and exhaust system generate high temperature during operation, which can easily cause scalding. Therefore, the parts can be touched only after the engine and exhaust system cool down.

#### CAUTION

This section lists some of important safety precautions. We cannot list all the dangers you may encounter during maintenance work.

### 6.2 Interior maintenance

#### Cleaning and maintenance of instruments and plastic parts

Clean the surface of instruments and plastic parts with a clean soft cloth and clean water.

If it cannot be cleaned, it is required to use a special solvent-free plastic cleaning agent for cleaning.

#### CAUTION

Solvent-based cleaning agents can damage plastic parts.

#### WARNING

**It is forbidden to clean the surfaces of instrument panel and airbag components with cab spray and solvent-containing cleaning agents. Otherwise, the surface may be loose and airbag may be triggered, which may cause serious injury to the occupants.**

### Cleaning and maintenance of carpet

Vacuum the dust on the carpet frequently.

Scrub the carpet regularly with detergent to keep it clean.

#### CAUTION

Please perform the cleaning in strict accordance with the use instructions of cleaning agents.

#### WARNING

**Do not add water to foam-type cleaners and keep carpets as dry as possible.**

### Cleaning and maintenance of leather\*

- Vacuum the dust.
- Clean the leather with a clean soft cloth and water.
- Wipe the leather dry with another dry soft cloth.
- If the cleaning methods described above are not enough to clean stains, please combine these methods with special leather cleaning soap or detergent.

#### CAUTION

After wiping with leather detergent, dry it with a soft dry cloth as soon as possible.

#### WARNING

**Never leave a soft cloth wet with leather stain remover on any part of the interiors for a long time. Avoid discoloring or breaking the resin or fibers of interior fabrics.**

### Cleaning and maintenance of seat belt

- Pull out the seat belt slowly and keep it in the pulled-out state.
- Use a soft brush and neutral soapy water to remove seat belt dirt.
- Wait for the seat belt to dry completely, and retract the seat belt.

#### CAUTION

- You must wait for the seat belt to dry completely before retracting it. Failure to do so may cause damage to the seat belt retractor.
- Check all seat belts in the vehicle regularly to ensure that the seat belts are clean so as not to hinder their normal operation.

## 6. Use and maintenance

---

### WARNING

- If webbing, connecting device, retractor or lock catch of seat belt is damaged, go to GAC Motor authorized shops for replacement as soon as possible.
- The seat belt must be replaced after the accident vehicle is overhauled, regardless of whether it is damaged or not.
- Prevent foreign matter or liquid from entering the seat belt lock catch, causing the lock catch and seat belt to fail to work normally.
- In any case, it is forbidden to disassemble and modify the seat belt without permission.
- It is forbidden to use chemical cleaning agent to clean the seat belt, so as not to cause damage to the seat belt base and affect its function.

### Cleaning and replacement of filters

The vehicle is equipped with air filter, A/C filter, oil filter, fuel filter, etc., which can filter gas or oil. If it is too dirty or clogged, it will affect the normal operation of the corresponding system. Therefore, it is recommended to go to the GAC Motor authorized shop to clean or replace the filter regularly according to the *Warranty Manual*.

## 6.3 Exterior maintenance

### Vehicle wash

Frequent vehicle wash helps to protect the appearance of the vehicle.

Vehicle wash shall be performed in a cool place, rather than under direct sunlight. If the vehicle is placed under sunlight for a long time, wait for the body to cool down before wash.

When using an automatic vehicle washer, be sure to follow the instructions of the operator of the automatic vehicle washer.

### WARNING

**The vehicle must be powered off before wash.**



### CAUTION

The strength of the body paint surface is sufficient to withstand the washing of the automatic vehicle washer, but attention must be paid to the impact on the paint surface. The structure of the automatic vehicle washer, the cleaning agent, the filtering state of the clean water, and the type of wax solvent that do not meet the requirements may cause damage to the paint surface.

### CAUTION

When there is dirt such as asphalt on the body, it is necessary to clean it with a special detergent and then rinse it with clean water to avoid damaging the surface finish of the body. While drying the body, check the body for paint peeling and scratches. If any, drive to the GAC Motor authorized shop for touch-up.

Use great care when cleaning vehicle with a steam cleaner or high-pressure cleaner. Be sure to clean in accordance with the instructions and requirements of the steam cleaner or high-pressure cleaner, and pay attention to the working pressure, temperature and spray wash distance:

- When using a steam cleaner or high-pressure cleaner to clean the vehicle, keep a sufficient distance from the vehicle, and the temperature shall not be higher than 60°C.

### Manual vehicle wash

- Rinse the vehicle with plenty of clean water to remove floating dust.
- Prepare a bucket of clean water and mix it with special detergent for vehicle washing.
- Wash the vehicle gently with a soft cloth, sponge or soft brush, and rinse from top to bottom for several times.
- The wheels, door sill and other parts shall be washed finally, and the sponge or soft cloth shall be replaced when washing the vehicle.
- After scrubbing, rinse the vehicle thoroughly with plenty of water.
- After cleaning, carefully dry the vehicle paint surface with a soft towel or antelope skin.

- Do not clean the radar sensor or parking camera with a high-pressure cleaner for a long time; When cleaning the radar sensor or parking camera, the water spray distance shall be more than 30 cm.

### WARNING

- **Pay attention to personal safety when washing the vehicle manually, and beware of vehicle bottom edges and corner parts to avoid scratches.**
- **When cleaning, pay special attention to the bottom of the vehicle and the inside of the wheel cover, and do not hurt your hands and arms by sharp parts.**
- **When cleaning the vehicle, do not directly flush water into the engine compartment. Otherwise, it will affect the service life of various parts and components in the engine compartment.**

## 6. Use and maintenance

---

### Waxing

Regular waxing can protect the body paint and keep the body smooth and clean. In order to effectively protect the body paint, it is recommended to apply high-quality hard wax once a year to protect the paint surface from external adverse environment and resist slight mechanical scratches.

Be sure to wipe the appearance of the entire vehicle dry before waxing. Before waxing the vehicle, please select a high-quality wax protectant. High-quality wax protectant generally falls into the following two types:

- Body wax: a wax used to protect the paint surface against damage due to external poor environments such as sun exposure and air pollution. This type of wax is generally used for new vehicles.
- Polishing wax: a wax which can restore the gloss of the paint surface that has been oxidized or tarnished. This type of wax is generally used to restore the gloss of paint surface.

### Cleaning and maintenance of external plastic parts

External plastic parts are generally washed with clean water, soft cloth and soft brushes. If they cannot be cleaned, please use the special solvent-free plastics cleaner approved by our company.

#### CAUTION

Solvent-containing cleaning materials shall not be used when cleaning plastic parts. Otherwise, it is easy to damage the plastic parts.

### Washing of windows and rearview mirrors

Clean the windows and rearview mirrors with an alcohol-containing glass cleaner, and then dry the glass surface with a clean lint-free soft cloth or antelope skin.

After care of the body surface, the wax remaining on the glass shall be removed with special cleaning agent and cleaning cloth, so as to avoid scratching the wiper blade.

Snow on windows and rearview mirror can be removed with a small brush.

Remove accumulated ice using de-icer spray. An ice shovel can also be used, but special care must be taken to avoid damage to the components, and ice must be shaved in the same direction.

### CAUTION

- It is forbidden to scrape the surface back and forth.
- It is forbidden to use warm or hot water to remove ice and snow from windshield and rearview mirror. Otherwise, it may cause glass burst.
- If there are residual rubber, grease and silicone substances on the glass, they must be removed with special window cleaner or silicone cleaner.

### Cleaning and maintenance of wiper cover plate

Try to avoid stopping under the tree frequently/ for a long time. If leaves or other debris are found on the upper surface of the wiper cover plate, please clean it in time.

### Cleaning of wiper blade

- Switch the vehicle power to the “ON” position and then to the “OFF” position.
- Set the wiper combination switch to the MIST position within about 10 s, and the wiper arm will run for half a cycle and then stop.

- Lift the wiper arm and carefully wipe off the dust and dirt on the wiper blade with a soft cloth.
- After cleaning, gently lower the wiper arm back to the windshield.
- Switch the vehicle power to the “ON” position, and the wiper will automatically return.

### CAUTION

- Be careful when lowering the wiper arm to prevent it from falling and hitting the windshield instantly.
- The wiper blade surface is coated with a layer of graphite, which can make the wiping smooth without scratching noise. Solvent-based cleaning agents, hard sponges and sharp objects can damage the graphite layer. The damage of the graphite layer will increase the wiping noise of the wiper, so it should be replaced in time.
- In winter or cold conditions, be sure to check that the wiper blades are not frozen to the windshield before using the wiper. If so, perform de-icing first. Otherwise, the wiper blades and wiper motor will be damaged.

### Maintenance of sealing strips

Frequent and proper protection of the rubber sealing strips of the doors, windows and other parts of the vehicle is intended to maintain their flexibility and prolong their service life. Such protection can also improve the tightness, make the door easy to open, reduce the impact sound of closing the door, and prevent freezing in winter.

When performing maintenance on sealing strips, remove dust and dirt from surfaces using a soft cloth. Apply special protective agent to rubber sealing strips regularly.

### Cleaning and maintenance of wheels

Regular removal of anti-skid salt and brake lining wear debris on the wheels can maintain the appearance and surface finish of the wheels, and prolong the service life. It is recommended to perform the following operations regularly:

- Remove the anti-skid salt and brake lining wear debris from the wheels with acid-free cleaner every two weeks.
- Apply high-quality hard wax to the alloy wheels every three months.

## 6. Use and maintenance

### CAUTION

- It is prohibited to maintain the wheel surface with vehicle polish or other abrasives.
- Wheels with damaged surface protective layer must be repaired in time.
- Using a high-pressure cleaner may cause permanent visible or invisible damage to the wheels, resulting in serious injury or death.
- It is forbidden to spray the tire with cluster nozzles, otherwise it will cause damage to the tire and cause traffic accidents.

## 6.4 Inspecting and adding oils

### 6.4.1 Fuel

As the amount of fuel decreases during vehicle running, the scale indication value on the fuel gauge will gradually decrease. => See page 38

When the fuel level is too low, the indicator lamp  will flash in yellow, and there will be a warning message on the instrument cluster. At this time, fuel should be added as soon as possible.

### NOTE

Fuel grade:

- 92# and above high quality unleaded gasoline.

### Add fuel



- Pull the fuel tank cover opening  handle, and the fuel tank cover will bounce outward.

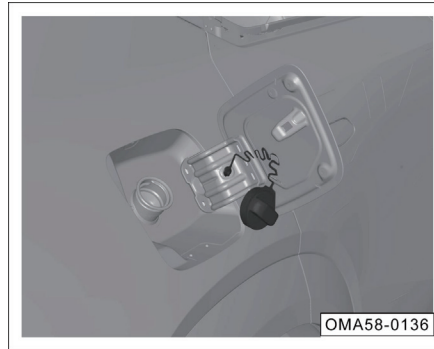
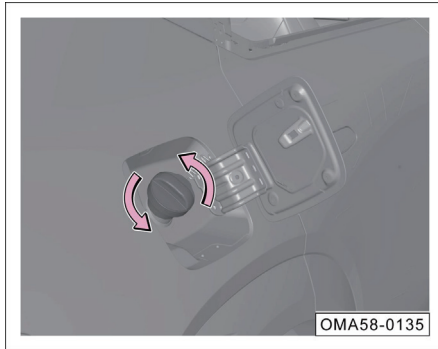

- Fully open the fuel tank cover plate, slowly unscrew the fuel filler cap counterclockwise in the direction of the arrow, and leave the fully unscrewed fuel filler cap in place for a while, so that the fuel tank can release the fuel vapor pressure inside, and then take it out.
- Hang the filler cap on the inside of the fuel tank cap plate and start to add the fuel.
- After refueling, tighten the filler cap clockwise until a "click" sound is heard, indicating that the filler cap is fully tightened.

### **i** NOTE

This model conforms to the China VI emission standards. The China VI fuel supply system design adopts a closed oil and gas recovery system. When refueling, the refueling gun switch may be triggered and the refueling gun may jump even the refueling is not enough due to high ambient temperature or too fast refueling, which is a normal phenomenon. In this case, the refueling should be slowed down.

### **👁** CAUTION

- Using low-grade fuel or substandard fuel may damage the engine or make the engine fail to meet performance requirements.
- When the fuel indication is less than 1/4, please refuel in time to avoid the vehicle breaking down due to insufficient fuel supply on the uphill and downhill sections.

## 6. Use and maintenance

### CAUTION

When refueling, it is necessary to insert the refueling gun into the deepest part of the fuel filler pipe. When the refueling gun jumps for the first time, it is recommended not to continue refueling to avoid fuel overflow due to excessive refueling.

### WARNING

- **At any time, be sure to shut down the engine when refueling, and note that there should be no open flames and kindling around.**
- **Please avoid contact of fuel with skin or clothing.**
- **Please add the fuel with appropriate grade. If you accidentally use the fuel that does not conform to the regulations, do not start the engine and contact the GAC Motor authorized shop immediately for treatment.**

### 6.4.2 Engine oil

#### Function of engine oil

Engine oil has functions such as lubrication, sealing, cooling, anti-rusting and cleaning.

#### Specifications of engine oil

When the vehicle leaves the factory, the engine has been filled with high-quality engine oil. Except for extremely cold weather, the engine oil can be used throughout the year.

When purchasing engine oil, please check whether the specifications indicated on the outer packaging of the engine oil are suitable for the engine of this vehicle.

### NOTE

Oil grade:

- API SN/ILSAC GF-5.

Oil viscosity:

- SAE 0 W-20.

### NOTE

- Be sure to go to the GAC Motor authorized shop to change the oil according to the period specified in the *Warranty Manual*.
- When driving the vehicle under severe conditions, or using the fuel with high sulfur content, or idling for a long time (such as taxis), or driving in high dust areas, or often towing a trailer, or driving the vehicle in alpine regions, the maintenance interval shall be shortened and maintenance frequency shall be increased.

### WARNING

**Always use the engine oil approved by our company. If oil of other grades is used, the engine damage caused by this will not be covered under the quality warranty.**

### Engine oil pressure warning lamp

When driving, if the warning lamp  comes on, be sure to stop the vehicle in a safe place and shut down the engine. After the engine cools down, check the oil level.

If the engine oil level is normal, but the warning lamp is still on after the engine is started, do not continue to start the engine. In this case, contact the GAC Motor authorized shop timely for inspection and repair.

#### WARNING

- Ignoring the warning lamp and related warning instructions may damage the engine.
- Low oil pressure warning lamp cannot indicate the oil level, so the oil level must be checked regularly.

### Inspecting the oil level

The oil level must be checked regularly. Stop the vehicle on a level ground and apply the parking brake, shut down the engine, open the hood after the engine cools down, and then check the oil level.

#### NOTE

When the oil level is checked, the engine shall be in cold state.

#### WARNING

- Be careful when working in the engine compartment.
- The front engine compartment is a high-risk area. Be sure to carefully read and observe the relevant warning instructions before opening the engine hood.

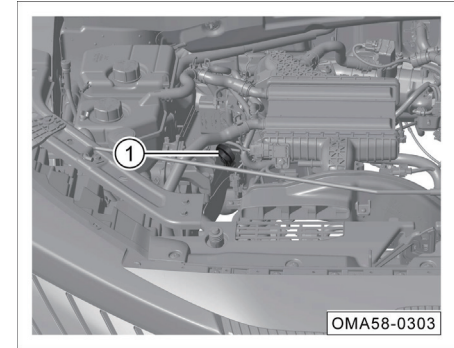

- Pull out the oil dipstick.

## 6. Use and maintenance

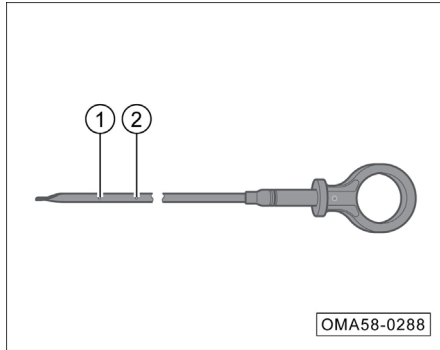

- Wipe off the oil stains on the dipstick using a clean cloth, and then insert the oil dipstick to the end.
- Pull out the oil dipstick again and read the measured oil level: the oil level should be between the minimum scale mark ① and the maximum scale mark ②.
- If there is too little engine oil, please add engine oil in time. Otherwise, poor lubrication will damage the engine.

### Add oil

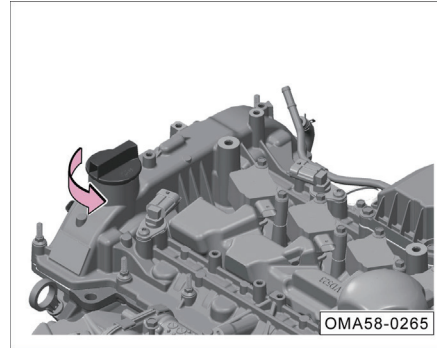

After checking the oil level, if it is necessary to add oil, please follow the following steps:

- Unscrew the oil filler cap counterclockwise.
- Add the oil in small quantities several times, and check the oil level after each filling.
- When the oil level is close to the maximum scale mark ②, stop adding, install the oil filler cap and tighten it clockwise.

### WARNING

- Be careful when adding the engine oil. Do not spill it. If the engine oil gets on skin, be sure to rinse the skin thoroughly.
- If too much oil is added, do not start the engine. In this case, please contact the GAC Motor authorized shop as soon as possible. Otherwise, the three-way catalytic converter may be damaged.
- After the filling is completed, the oil filler cap must be tightened in case the oil splashing when the engine starts and causes a fire.
- The engine oil is a toxic substance. Store the engine oil in the original container and keep out of reach of children to avoid poisoning by accidental ingestion.
- Do not add other lubricants to the engine oil, otherwise the engine will be damaged, and the fault caused by adding lubricant is not within the scope of warranty.



### 6.4.3 Coolant

#### Function of coolant

Coolant has functions such as cooling, anti-freezing and anti-corrosion.

#### Specifications of coolant

When the vehicle leaves the factory, the cooling system has been filled with coolant. Except for extremely cold weather, the coolant can be used throughout the year.

#### NOTE

- Coolant specifications: DF-6, -35 °C coolant.
- Be sure to go to the GAC Motor authorized shop to change the coolant according to the period specified in the Warranty Manual.
- If the coolant changes color, shorten the maintenance interval and go to the GAC Motor authorized shop for change.

#### High engine coolant temperature indicator lamp

If the coolant temperature is too high, the indicator lamp on the instrument cluster will light up in red, and a warning message will prompt the driver; At this time, the vehicle must be stopped and the engine must be shut down in a safe place. After the engine cools down, check the coolant level.

If the coolant level is normal but the indicator lamp is still on after the engine is started, do not continue to start the engine. In this case, contact the GAC Motor authorized shop timely for inspection and repair.

#### Check coolant level

The coolant level must be checked regularly. Stop the vehicle on a level ground and apply the parking brake, shut down the engine, open the engine hood after the engine cools down, and then check the coolant level.



#### WARNING

- **Be careful when working in the engine compartment.**
- **The front engine compartment is a high-risk area. Be sure to carefully read and observe the relevant warning instructions before opening the engine hood.**
- **If you see steam or coolant spilling out of the engine compartment, do not open the hood to prevent scalding; Wait till there is no steam or coolant overflowing and the engine cools down before opening the engine hood.**

## 6. Use and maintenance

### Engine coolant

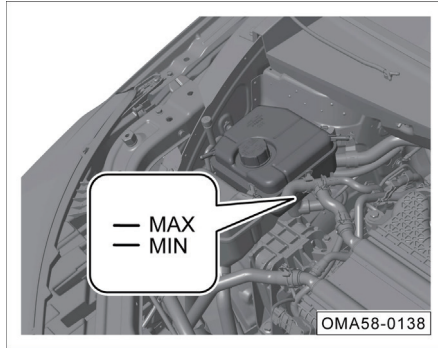

Check whether the coolant level in the engine coolant expansion tank is between the maximum scale mark "MAX" and the minimum scale mark "MIN".

### Intercooler coolant

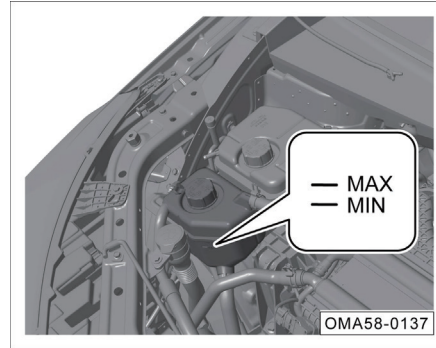

Check whether the coolant level in the intercooler coolant expansion tank is between the maximum scale mark "MAX" and the minimum scale mark "MIN".

#### CAUTION

When the coolant level is below the lower limit mark "MIN", the coolant must be added. If the cooling level is too low, the cooling effect will be affected and the engine or intercooler will be damaged.

### Add coolant

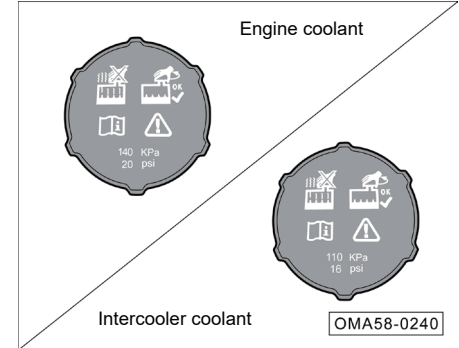

After checking the coolant level, if it is necessary to add coolant, please follow the following steps:

- Wrap the expansion tank cap with a thick cloth and unscrew it counterclockwise.
- Add the coolant to between the maximum scale mark "MAX" and the minimum scale mark "MIN".
- Tighten the expansion tank cover clockwise to the lock stop.

### CAUTION

- When the engine is not cooled, the cooling system is in a high-pressure state. Do not open the coolant expansion tank cover, otherwise you will be scalded by the emerging coolant.
- The coolant can only be added after the engine or intercooler is cooled down. The fluid level of the coolant after adding shall not exceed the maximum scale mark "MAX", otherwise the coolant will overflow when the engine is started and the cooling system is under high pressure.
- Only new coolant can be added.

### WARNING

- **It is forbidden to mix coolant that have not been approved by our company in the original coolant.**
- **In case of emergency, if other coolant or pure water is added, you should go to the GAC Motor authorized shop to clean the cooling system and change with new coolant.**
- **If you find that the coolant is consumed too much or too fast, there may be leakage in the cooling system, and you should go to the GAC Motor authorized shop for inspection and repair in time.**
- **Coolant must be contained in the original container, and kept out of children's contact to avoid poisoning due to accidental ingestion.**

## 6. Use and maintenance

### 6.4.4 Windshield washer fluid and wiper blade

#### Add windshield washer fluid

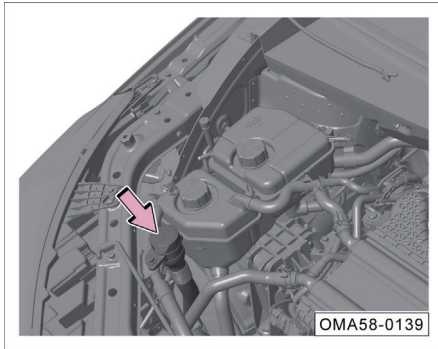

- If the washer fluid level is found to be too low, add the washer fluid into the reservoir in time.

#### CAUTION

- Never use soapy water or other antifreezes to replace washer fluid, otherwise it may cause markings on the paint surface of the vehicle.
- Do not mix the windshield washer fluid with other washing liquids, otherwise it will cause the washer fluid components to decompose and block the windshield washer nozzle.

#### WARNING

- Be careful when working in the engine compartment. Be sure to carefully read and follow the relevant warning instructions before starting work.
- Do not mistakenly use coolant or any other additives as the windshield washer fluid, otherwise it will leave oil stains on the windshield when cleaning the windshield, which will affect the vision and easily cause accidents.
- It is forbidden to use windshield washer fluid with ethanol content exceeding 10%. Under high temperature environment, this type of windshield washer fluid will have corrosion effect on lamps and lead to lamp cracking. Methanol washer fluid is recommended.

### Replace front windshield wiper blade

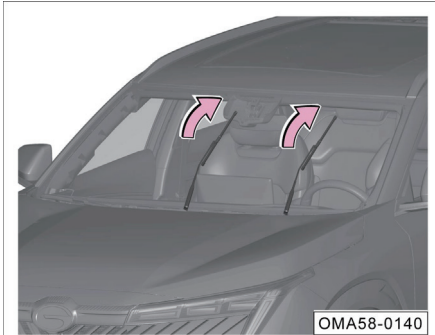

- Switch the vehicle power to the “ON” position and then to the “OFF” position.
- Set the wiper combination switch to MIST position within about 10 s, and the wiper arm will run for half a cycle and then stop.

### i NOTE

When the wiper switch is in the “OFF” position, in the AV system “Setting → Body Accessories → Other Accessories”, click the soft key of “wiper maintenance mode”, the wiper arm will stop after half a cycle of operation; click the right soft key, and the wiper arm will reset.

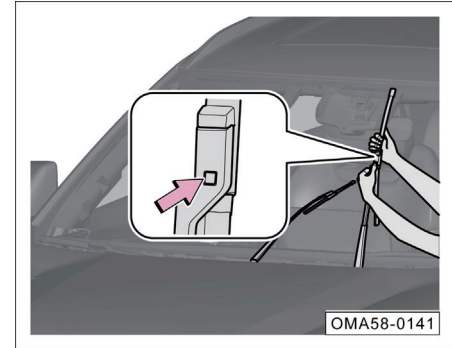

- Pull up the wiper arm, press the locking button-arrow-, and remove the wiper blade.
- Slowly lower the wiper arm.
- Install the new wiper blade to the wiper arm according to the reverse steps until you hear a “click” sound.
- Gently put the wiper arm back onto the windshield.
- Switch the vehicle power to the “ON” position, and the wiper arm will automatically return.

## 6. Use and maintenance

### CAUTION

- The wiper arm can be pulled up only after it is adjusted to the wiper maintenance mode.
- Do not open the hood when the wiper is pulled up, otherwise the hood and wiper arm will be damaged.
- When pulling up the wiper arm, please hold the wiper arm by hand instead of the soft wiper blade.
- New wiper blades with the same length and specifications must be used.
- Be careful when lowering the wiper arm to prevent it from falling and hitting the windshield instantly.
- The status of wiper blades must be checked regularly and replaced as required. Damaged wiper blades must be replaced in time.
- Excessive worn or dirty wiper blades are easy to scratch the windshield, and will affect the field of vision and reduce driving safety during use.

### 6.4.5 Brake fluid

#### Brake fluid function

Brake fluid is used to transmit power in the vehicle hydraulic brake system.

The brake fluid is water-absorbent and it continuously absorb moisture in the surrounding air during use. If the brake fluid remains in the system for a long time and the water absorption is too high, air resistance will be generated in the system pipeline during braking, which will reduce the braking effect, affect the driving safety, and even lead to complete failure of the brake system, causing accidents. Therefore, be sure to go to the GAC Motor authorized shop to check the brake fluid level or change the brake fluid according to the period specified in the *Warranty Manual*.

#### NOTE

Brake fluid specification: DOT4.

### WARNING

- **The use of waste brake fluid or improper brake fluid will greatly reduce the braking effect and even cause brake system failure! The company does not assume any liability (including warranty) for vehicle failure and damage caused thereby.**
- **Compliant brake fluid must be used and must be new.**

#### Brake system indicator lamp

When the vehicle is running, if the indicator lamp  is red and the instrument cluster displays the message "Please add brake fluid", stop the vehicle at a safe place immediately and check whether the brake fluid level is normal.

### Check brake fluid level

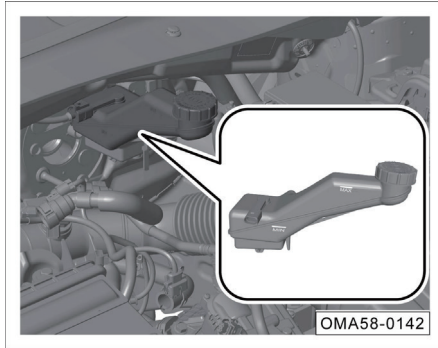

After the engine has cooled down, check whether the brake fluid level is between the maximum scale mark "MAX" and the minimum scale mark "MIN".

During the use of the vehicle, the brake fluid level will slightly drop due to the worn brake linings and automatic adjustment.

If the brake fluid level drops significantly or drops below "MIN" in a short period of time, it indicates that there may be a leakage in the brake system.

### **i** NOTE

- **Be sure to carefully read and observe the relevant warning instructions before opening the engine hood.**
- **If the brake level is below the lower limit mark "MIN", brake fluid must be added.**
- **If the brake system warning lamp does not go out or comes on again during driving after adding the brake fluid, there may be leakage in brake system that causes the brake level decreasing too fast or the brake system may be faulty. In this case, do not continue driving. Please contact the GAC Motor authorized shop for inspection and repair in time.**

### Add brake fluid

In order to ensure the normal operation of the brake system, the added brake fluid shall meet the specification:

- Unscrew the brake fluid reservoir cover counterclockwise.
- Stop adding when the fluid level reaches the maximum scale mark "MAX".
- Tighten the brake fluid reservoir cover clockwise.

## 6. Use and maintenance

### CAUTION





- The brake fluid corrodes body paint. The brake fluid spilled on the paint shall be wiped off in time.
- The use of waste brake fluid or improper brake fluid will greatly reduce the braking effect due to incompatibility, and even lead to brake system failure.

### WARNING

- **Brake fluid is a poisonous substance and must be packed in the original sealed container and placed in a safe place. Beware of children's contact, so as to avoid poisoning by accidental ingestion.**
- **Brake fluid must be stored in accordance with environmental protection laws.**

### 6.4.6 Battery

#### Battery operation warning symbols and instructions

	Goggles must be worn during operation!
	The battery electrolyte is highly corrosive. Protective gloves and goggles must be worn during operation!
	Open flames, sparks, uncovered lamps and smoking are prohibited in the workplace!
	Extremely explosive gas mixture is generated during battery charging !
	Children must keep away from electrolyte and vehicle battery !

If you are not familiar with the operation process or do not have special tools, you must not carry out any work on the electrical system of the vehicle. The relevant work should be carried out by the GAC Motor authorized shop.

#### Charging system warning lamp

This warning lamp is used to indicate an alternator fault.

When the vehicle power is in the "ON" position and the engine is not started, the warning  lamp will come on. After the engine is started, the warning lamp will go out.

When the vehicle is running, if the warning lamp comes on, it indicates that the alternator will no longer charge the battery. In this case, please go to the GAC Motor authorized shop for inspection and repair as soon as possible.



### Check the battery

The battery must be checked according to the interval specified in the *Warranty Manual*.

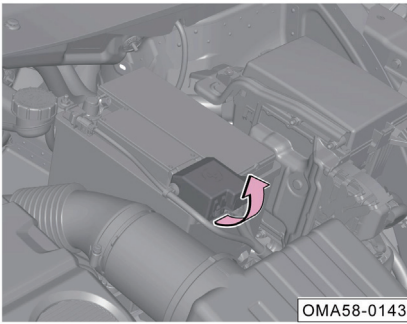

- Flip up the cover of the battery's positive terminal.
- Check the connection of the battery connector and the cable for corrosion or looseness; check the appearance of the battery for cracks, swelling, etc. If the phenomena above are found, please go to the GAC Motor authorized shop for inspection in time.
- If the vehicle has not been used for a long time, the condition of the battery should be checked frequently.

### **i** NOTE

- If the battery level is insufficient or the battery is damaged, which makes it difficult to start the vehicle, please contact the GAC Motor authorized shop in time to charge or replace the battery.
- If you need to replace the battery, please go to the GAC Motor authorized shop for replacement; If the battery of wrong model is used, the vehicle may be unusable or the electrical system failure may be caused due to incompatibility.

### Instructions for use of battery

If the engine is shut down and the on-board electrical equipment is used, the battery will discharge quickly:

1. Do not use an electrical consumer on the vehicle for a long time after the engine is turned off.
2. When leaving the vehicle, make sure that the doors are closed and all electrical equipment (such as lights) are off.

### **👁** CAUTION

- If the engine cannot be started due to lack of battery power, you can try to start the engine by emergency. If the engine still cannot be started, please contact the GAC Motor authorized shop for inspection and repair.
- To avoid damaging the vehicle electrical system, never connect power generation equipment such as solar panels or vehicle battery chargers to the power outlet.
- The battery contains toxic substances such as sulfuric acid and lead, so it must be properly disposed of and must not be treated as ordinary household waste.

## 6. Use and maintenance

---

### 6.5 A/C filter

#### Inspecting and cleaning the A/C filter

Check or clean the A/C filter regularly according to the warranty manual. If the vehicle is running in a dusty environment, which causes the A/C filter to be too dirty, it is recommended to replace the A/C filter earlier.

The A/C filter is located inside the glove box on the front passenger side. When removing the A/C filter, it is complicated to remove the parts. In order to avoid unnecessary damage to the parts, it is recommended to check and clean or replace the A/C filter in the GAC Motor authorized shop.

### 6.6 Replacing bulb

#### Instructions for replacing bulbs

The lamps of the vehicle are LED ones, which cannot be disassembled or replaced separately. In case of bulb damage or function failure, please go to the GAC Motor authorized shop for inspection and repair in time.

#### WARNING

**Retrofitting of exterior lighting and signaling devices is prohibited.**

### 6.7 Wheel

#### WARNING

**The road adhesion of new tires within the first 500 km cannot reach the best state, so drive the vehicle carefully at a moderate speed to prevent accidents.**

- **The road adhesion of non-running-in or excessively worn tire is insufficient, which directly affects the braking effect.**
- **If abnormal vibration or deviation of the vehicle is found during vehicle driving, stop the vehicle immediately and check whether the tire is damaged.**
- **If you find uneven and excessive tire wear, go to the GAC Motor authorized shop for inspection as soon as possible.**

### WARNING

If tires burst or leak when the vehicle is running, it is very easy to cause serious traffic accidents.

- Never use damaged tires and wheels or use tires whose treads have been worn to the wear indicator. Otherwise, it is very easy to cause accidents, because such tires may burst during driving, causing traffic accidents and injuries. Such tires and wheels shall be replaced in a timely manner.
- The tire air pressure must comply with the regulations, otherwise, accidents may occur. If the tire pressure is insufficient, the vehicle driving at high speed will cause the tire to deflect, and the tire will easily overheat, which may cause tire shelling or tire burst.
- Never expose tire to chemicals, oil, grease, fuel and brake fluid.

### WARNING

- Used wheels and tires of unknown origin should not be used under any circumstances, as such wheels and tires may be damaged without visible damage and may cause loss of control and an accident while the vehicle is in motion
- It is recommended not to use retread tire. As the service life of such tires passes, the carcass may change, and the durability may also be limited and the driving safety may be affected.

### Wheel failure preventive measures

- The vehicle shall run slowly in the obstacle vertical direction as far as possible when passing over curb or similar obstacle.
- Do not contact the tire with grease, oil and fuel.
- Regularly check the tire damage (such as cutting, wear, falling off, deformation or bulge).
- Regularly remove debris embedded in the grooves of the tire pattern.

### Tire storage instructions

- Before removing the tire, mark the tire to indicate the rotation direction of the tire, and reset it according to the mark when installing the tire to keep the rotation direction and dynamic balance state of the wheel unchanged.
- The removed wheels or tire should be stored in a cool and dry place, preferably in a dark place.
- The tire mounted on the rim shall not be stored upright.

## 6. Use and maintenance

---

### New tires and wheels

- The new tires and wheels must be carefully selected to ensure that their size, load range, rated speed and structure type are the same as the original tires as much as possible.
- Do not replace only one tire separately, but at least replace two tires on the same axle at the same time.
- Do not mix tires of different sizes or types, and do not mix summer, all-season and winter tires.
- After each wheel installation, check whether the wheel bolt tightening torque (125±10 N·m) meets the requirements.

### Non-full-size spare tire

Spare tires and standard tires are different in aspects such as structure, pattern, speed rating and load index, and cannot be exchanged.

After emergency use of the spare tire, it is necessary to drive safely to the GAC Motor authorized shop or wheel repair shop for full-size tire replacement as soon as possible to avoid driving safety hazards caused by long-term use of the spare tire.

#### WARNING

- **The spare tire can only be used for temporary emergency, and the maximum driving speed shall not exceed 80 km/h.**
- **The storage life of spare tire is 6 years, and it is forbidden to use it beyond the expiration date.**

### Summer tire

In rainy summer, the tire tread depth directly affects the driving safety of the vehicle on rainy days. There is a high risk of water slip when the summer tire tread depth is less than 3 mm.

### Winter tire

The winter tire still has good grip performance when the road is covered with ice and snow. The special tread rubber design makes the tire less affected by the low temperature environment and has excellent braking ability, which ensures the driving safety of the vehicle.

- Use winter tires on all four wheels.
- Use only radial winter tires approved for this vehicle and of the same size, load range and speed rating as the original tires.

- Please note that the winter tire tread shall have sufficient pattern depth (the tire tread depth shall not be less than 4 mm; when it is less than 4 mm, the applicability is limited in winter).
- After installing the tire, check the tire inflation pressure.

### ⚠ WARNING

- Winter and summer tires are designed according to their respective typical lane driving conditions under the corresponding seasonal conditions. It is recommended to use winter tires in winter. At low temperatures, the adaptability of summer tire is significantly poorer, resulting in a loss of road adhesion and braking ability.
- In severe cold conditions, if the summer tires are used, cracks may appear on the tires, which can completely damage them and cause excessive tire noise and loss of balance.

### ⚠ WARNING

- After using the winter tire, there may be reduced driving traction on dry roads, increased road noise and shortened tread life. Please pay attention to the changes in vehicle handling and braking after the use of winter tire.
- Please note that the maximum speed applicable to the winter tire is relatively low, and do not exceed the maximum speed allowed by the tire.
- Please note that when the driving weather rises above 7°C, please replace the summer tire in time to ensure driving safety and performance.
- When driving with winter tires, if a spare wheel is installed, unstable turning characteristics will be produced due to different tires, which will weaken the driving stability. It is necessary to adjust the driving style and drive carefully.

### Check tire pressure

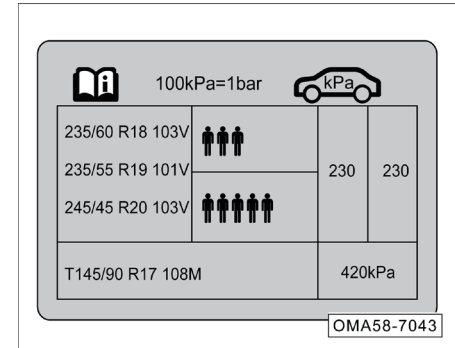

The standard pressure data label of the original tires of this vehicle is attached to the driver's side B-pillar.

- Unscrew the valve cap (if the valve cap is lost, it shall be added in time).
- A high-quality tire pressure gauge is required to check the tire pressure. It is impossible to determine whether the tire pressure is appropriate only by visual inspection.
- Install the tire pressure gauge on the valve.
- When conducting the tire pressure inspection, the tire must be in a cold state. When the temperature increases, the tire pressure can be slightly higher than the specified value, and it is not necessary to reduce the tire pressure.

## 6. Use and maintenance

- Balance the weight of occupants and luggage, avoid slopes, and adjust tire pressure according to vehicle load.
- Check the tire pressure of spare wheel or emergency spare wheel at the same time.
- Install and tighten the valve cap.

### i NOTE

- The current tire pressure can be checked through the information on the instrument cluster display.
- Be sure to refit the valve cap to the valve core. The valve cap prevents the ingress of dust and moisture.

### ⚠ WARNING

- **Abnormal tire pressure may lead to tire burst, causing traffic accidents, injury or even death.**
- **Check the tire pressure at least once a month or before long-distance driving. The tire pressure must meet the specified requirements to prevent accidents.**
- **Insufficient tire pressure will aggravate the deflection of the tire, and the tire will easily overheat, which may cause tread shelling and tire burst.**
- **Too low or too high tire pressure will cause early wear of the tire and reduce the steering stability of the vehicle.**

### Tire service life

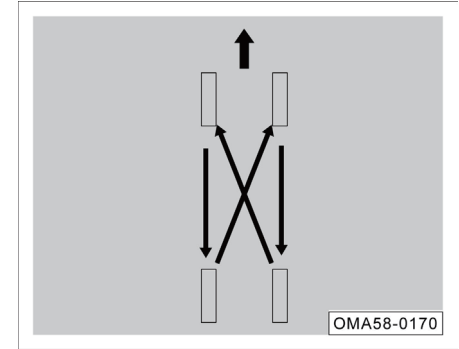

Tire service life depends on tire pressure, driving habits and tire assembly conditions.

If the wear of the front wheel tire is more serious than that of the rear wheel tire, it is recommended that the front and rear wheels be rotated and installed as shown in the figure, so that the service life of all tires is roughly the same .

### Tread wear indicator

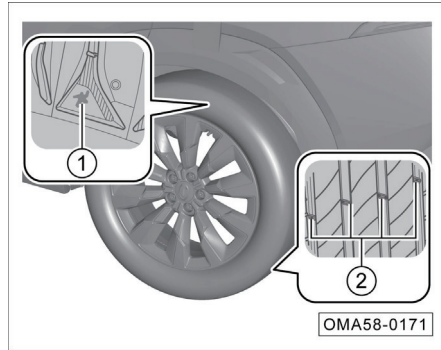

The pattern ① is used to indicate the wear of the outer circular pattern of the tire. If the outer circular of the tire is worn to the pattern, the tire can no longer be used safely and must be replaced immediately.

The “tread wear indicator” ② is 1.6 mm in height. If the tread pattern is worn to the surface of the wear indicator, the tire can no longer be used safely and must be replaced immediately.

### Wheel balance

The wheels of the new vehicle are balanced, but during operation, the wheels may be unbalanced due to various reasons, which can be manifested by the vibration of the steering mechanism.

Because unbalanced wheels can cause excessive wear on the steering system, wheel suspension mechanism and tires, the wheels shall be rebalanced.

In addition, each wheel must be rebalanced after installation of a new tire or after tire repair.

### Wheel misalignment

Inaccurate wheel alignment will cause uneven and excessive tire wear and affect the driving safety. If you find any uneven and excessive tire wear, please go to GAC Motor authorized shop to check the wheel alignment in time.

## 6.8 Tire chain

When driving in harsh environments such as snow or icy roads in winter, it can increase the degree of tire wear or cause other failures. To reduce failures in winter, the following opinions must be followed:

- When driving the vehicle in deep snow, it is necessary to install tire chains on the tires. If snow chains are installed, the equivalent of the size and type corresponding to the tire specifications on the vehicle must be selected. Failure to do so will adversely affect the performance and safety of the vehicle. Moreover, full-load driving, speeding, emergency acceleration, emergency braking, emergency turning and other operations are potentially very dangerous.
- During deceleration, make full use of the engine braking function. Emergency braking on roads with snow or ice will cause the vehicle to drift and slip. Keep a proper safety distance from the vehicle ahead and depress the brake pedal slightly. It should be noted that the tire chains installed on tires can provide some friction, but can not prevent sideslip.

## 6. Use and maintenance

---

### NOTE

Different countries or regions have different regulations for tire chains, and the regulations of each country or region should be consulted before assembling tire chains. Do not install tire chains without being aware of the regulations in each country or region that may restrict the use of such chains.

### CAUTION

- Install tire chain on the tires to ensure balanced driving in all kinds of weather. It should be remembered that the vehicle power may be insufficient after the tire chains are installed. Even if the road surface is in good condition, drive carefully. When driving, do not exceed the specified speed limit of the tire chain, and do not exceed 50 km/h, whichever is lower.

### CAUTION

- If tire chains are installed on the tires, the size and type of the tire chains shall be consistent with the standard tires on the vehicle, otherwise, the safety and handling of the vehicle will be adversely affected.
- The tire chains shall be installed on the front tires in pairs but not the rear tires.
- Do not install tire chains on emergency spare tires. If a spare tire is installed on the front tire and a tire chain is required, be sure to exchange the position of the spare tire with the rear tire.
- Do not use tire chain on dry ground. After driving to a snow-free road, remove the tire chain.
- Install the tire chain as close to the front tire as possible, then drive the vehicle for 0.5~1.0 km, and tighten the snow chain again.



### 7.1 Vehicle identification number (VIN)

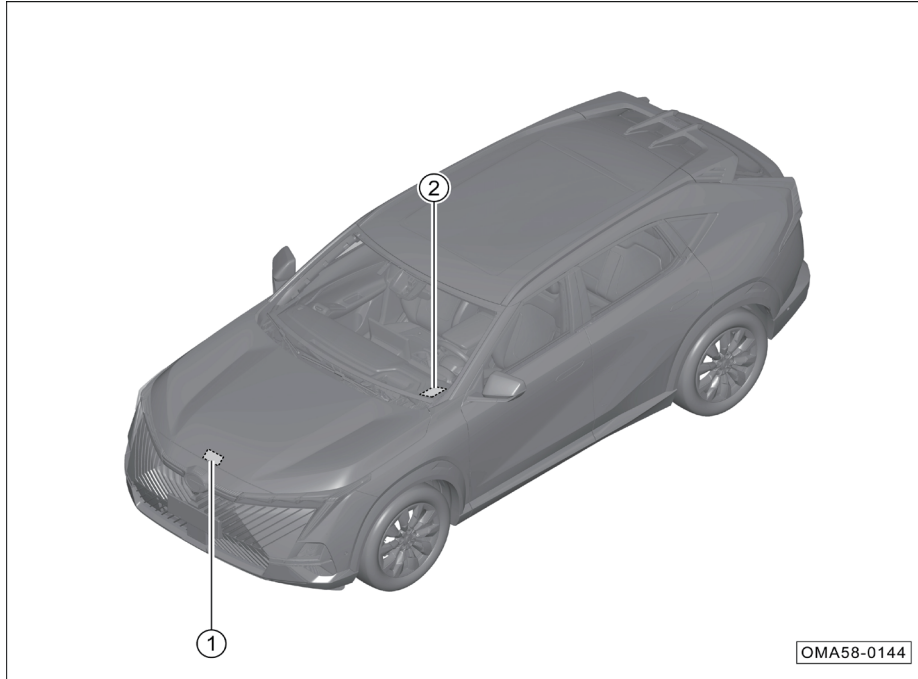

The location of the VIN is as shown in the figure:

- ① VIN: engine hood
- ② VIN: instrument panel left side.

#### **i** NOTE

The location indication and quantity of VIN are not complete. Please refer to the actual vehicle.

## 7. Technical data

### OBD DLC

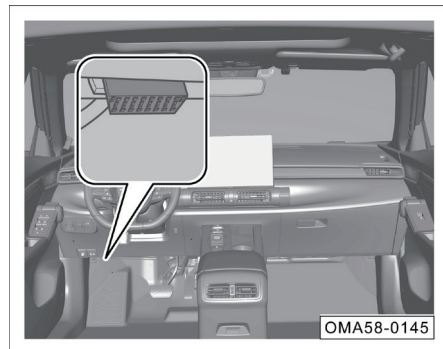

The OBD DLC for reading the electronic VIN is located at the lower left of the instrument panel. The electronic VIN and vehicle status information can be read through a special diagnostic scan tool.

#### **i** NOTE

If you need to purchase diagnostic scan tool, please go to the GAC Motor authorized shop for consultation and purchase.

### Vehicle nameplate



The vehicle nameplate is attached to the driver's side B-pillar.

#### **i** NOTE

The figure is for reference only, so please refer to the actual vehicle.

### Engine model and serial number

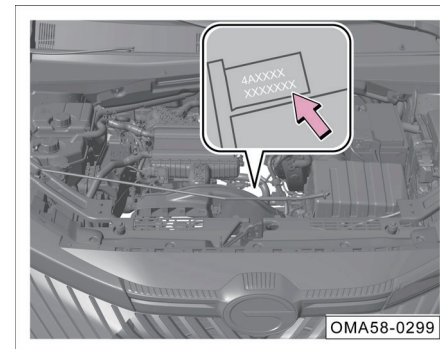

Engine model and serial number -arrow- is located on the engine block (above the starter).

### 7.2 Vehicle dimension parameters

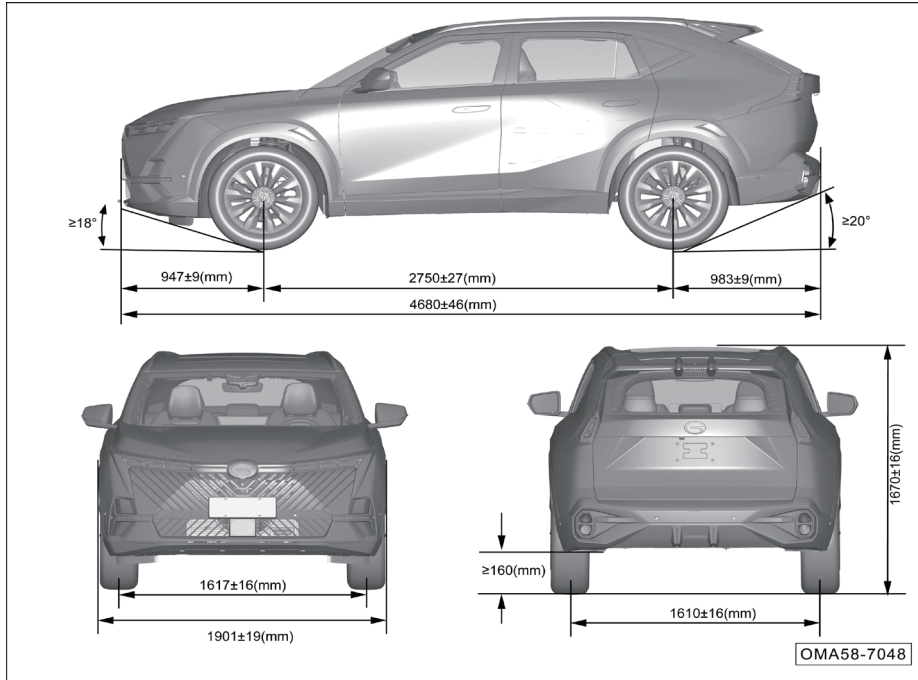

#### Dimensions

Item	Parameters		
	Value	Unit	
Overall length	4680±46	mm	
Overall width	1901±19	mm	
Overall height	1670±16	mm	
Wheelbase	2750±27	mm	
Wheel track	Front wheel	1617±16	mm
	Rear wheel	1610±16	
Front suspension	947±9	mm	
Rear suspension	983±9	mm	
Minimum ground clearance (fully loaded)	$\geq 160$	mm	
Approach angle (fully loaded)	$\geq 18$	°	
Departure angle (fully loaded)	$\geq 20$	°	

Note: The exterior rearview mirrors (each one on the left and right) near the junction of the lower end of the A-pillar and the front door, and the antenna above the rear of the roof are not included in the outer width dimensions.

## 7. Technical data

### 7.3 Vehicle mass, engine and oil parameters

#### Mass

Model	Kerb mass (kg)			Maximum gross mass (kg)		
	Kerb mass (kg)	Front axle load	Rear axle load	Maximum gross mass	Front axle load	Rear axle load
GAC7151HCW6A	1500±45	882±26	618±18	1915	1007	908
	1540±46	893±26	647±19			

#### Comprehensive parameters

Item	Corresponding model parameters	Unit
	GAC7151HCW6A	
STT	Non-STT	/
Seating capacity	5	Person
Minimum turning diameter	11.0	m
Maximum gradeability	40	%
Maximum speed	190	km/h
Combined fuel consumption under NEDC	≤6.6	L/100km

## 7. Technical data

### Engine parameters

Model	4A15J2
Layout type	Transverse front
Type	Gasoline engine, spark ignition, in-line, four-cylinder, four-stroke, turbocharged and intercooled, GDI, DOHC, exhaust gas turbocharger
Number of cylinders (pcs)	4
Ignition order	1-3-4-2
Cylinder bore (mm)	74
Stroke (mm)	87
Displacement (mL)	1497
Compression ratio	(11.5±0.3):1
Rated power/speed (kW/(r/min))	130/5500
Maximum net power/speed (kW/(r/min))	125/5500
Maximum torque/speed (N • m/ (r/min))	270/1400~4500
Maximum net torque/speed (N • m/ (r/min))	250/1400~4500
Stable idling speed (r/min)	700±50
Emission level	China VI

## 7. Technical data

### Oil specification and capacity

Item	Specification	Capacity	
Fuel <sup>1)</sup>	91# and above high quality unleaded gasoline	Total	55L
Engine coolant <sup>2)</sup>	Coolant: DF-6, -35°C	Total	8.2±0.1L
Engine oil	Oil grade: API SN/ILSAC GF-5 Oil viscosity: SAE 0W-20	Total <sup>3)</sup>	4.5L
		Replacement <sup>4)</sup>	4.2L
WDCT lubricating oil	Shell Spirax S5 DCT 12 Plus	Total <sup>5)</sup>	6.9L
		Replacement <sup>5)</sup>	5±0.2L
Intercooler coolant	Coolant: DF-6, -35°C	Total	3.3±0.1L
Brake fluid	DOT4	Total	0.78±0.15L
Windshield washer fluid	Methanol, with freezing point of -30°C; 44% methanol and 56% water with hardness no more than 205 g/t	Total	2±0.5L
A/C refrigerant	HFC-134a	Total	530±25g

- Note: 1) Long-term filling of fuel with a sulfur content higher than the standard may cause excessive emissions. Please pay attention to using fuel that meets the local standards for vehicle sales.
- 2) The coolant in the reservoir and the residual coolant in the engine are included.
- 3) The capacity for overhaul of engine assembly.
- 4) The replacement of oil filter is included.
- 5) For non-special circumstances (such as transmission fluid leakage), it is recommended to “add as much as you drain”.

### 7.4 Transmission, chassis and lamp specifications

#### Transmission parameters

Model	7WF25C
Type	WDCT
Drive	2WD
Final drive ratio	4.389(5124R gears)
	2.724 (736 gears)
1st gear	3.846
2nd gear	2.308
3rd gear	2.500
4th gear	1.140
5th gear	0.911
6th gear	1.180
7th gear	0.946
Reverse gear	3.491

#### Suspension

Type	Front suspension	Rear suspension
	McPherson, independent	Multi-link freestanding suspension

#### Wheel

Specifications of rim	7J × 18 *, 7.5J × 19 *	
Tire specifications	235/60R18*, 235/55R19*	
Tire air pressure	No load	fully loaded
	230kPa	230kPa
Spare tire specifications	T145/90R17	
Spare tire pressure	420kPa	

#### Steering gear

Type	Rack and pinion electric power steering gear
Assist type	Electric power

#### Brake

Type	X-type double circuit, hydraulic brake, vacuum booster
Front wheel	Disc brake
Rear wheel	Disc brake
Parking brake	EPB

## 7. Technical data

### Dynamic balance of wheels

Name		Residual dynamic unbalance
Front wheel	Inside	≤8 g
	Outside	≤8 g
Rear wheel	Inside	≤8 g
	Outside	≤8 g

### Brake pedal free stroke

Name	Parameters
Stroke	106±3mm
Free stroke	≤11 mm

### Brake lining technical parameters

Name	Parameters
Front wheel brake lining wear limit (excluding brake lining backing plate)	2mm
Rear wheel brake lining wear limit (excluding brake lining backing plate)	2mm

### Wheel alignment parameters

Name		Parameters
Front wheel	Individual toe-in	4'±3'
	Wheel camber	-16'±30'
	Kingpin caster angle	7°12'±45'
	Kingpin inclination angle	12°59'±45'
Rear wheel	Individual toe-in	2'±3'
	Wheel camber	-55'±30'

### Battery

Item		Parameters
Parameters	Rated voltage	12V
	20-hour rate capacity	55Ah
	Low temperature start current (EN)	550A

### Driving form

Driving form	Front wheel drive
--------------	-------------------



## 7. Technical data

### Lamps

Lamps	Model	Power
High beam	LED	/
Low beam	LED	/
Daytime running lamp *	LED	/
Front turn signal lamp	LED	/
Front position lamp	LED	/
Rear fog lamp	LED	/
Side turn signal lamp	LED	/
Brake lamp	LED	/
Rear position lamp	LED	/
High-mounted stop lamp	LED	/
Rear turn signal lamp	LED	/
Reverse lamp	LED	/

Lamps	Model	Power
License plate lamp	LED	/
Front roof lamp	LED	/
Rear dome lamp	LED	/
Trunk lamp	LED	/
Ambient light	LED	/

The lamps of the vehicle are LED ones. For replacement => [See page 214](#).

## 7. Technical data

### 7.5 Fuse specifications

#### Fuse in instrument panel PDU

The fuses may slightly vary from vehicle to vehicle. In this regard, the actual vehicle shall prevail.

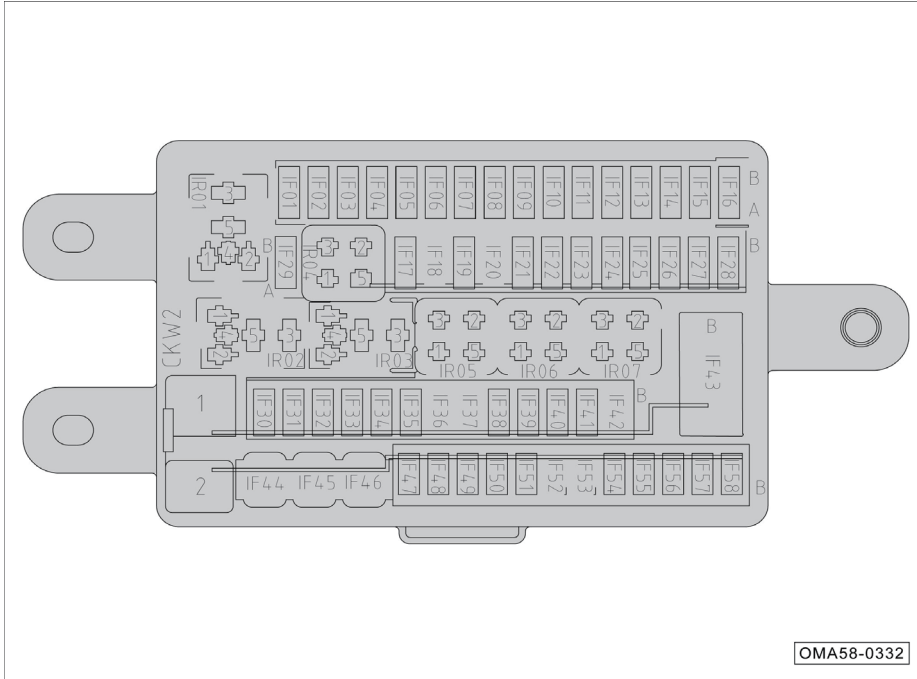

## 7. Technical data

No.	Rated value	Feature/part
IF01	20A	Front 12V power outlet
IF02	7.5A	Integrated BCM*/BCM*/PEPS ECU*
IF03	7.5A	AV control uni*/GWM */exterior rearview mirror adjusting switch *
IF04	7.5A	Rear USB port
IF05	20A	USB_TYPE_C interface
IF06	—	—
IF07	7.5A	GWM */T-BOX ECU*
IF08	20A	AV control unit *
IF09	20A	Left front seat connector (HVSM) *
IF10	10A	Rain and light sensor */touch control screen
IF11	10A	GWM / A/C control unit / Left front seat connector (HVSM) *
IF12	—	—
IF13	7.5A	Blower relay (ER05)/PEPS ECU*/integrated BCM *
IF14	20A	Integrated BCM*/BCM*
IF15	10A	Instrument cluster display
IF16	—	—
IF17	10A	Airbag control unit
IF18	7.5A	WDCT control unit / engine control unit

No.	Rated value	Feature/part
IF19	7.5A	GWM / PEPS ECU*/ T-BOX ECU */BCM*/ instrument cluster */ integrated BCM *
IF20	7.5A	Brake switch
IF21	7.5A	ESPI
IF22	7.5A	Gearshift lever module/ electronic P gear actuator/ HVAC control unit/ negative ion generator */ EPS control unit
IF23	7.5A	Panoramic sunroof sunshade */ left front seat connector (HVSM) *
IF24	—	—
IF25	7.5A	Left instrument panel switch block/ left rear combination lamp/air quality sensor */ right front combination lamp
IF26	7.5A	RPA ECU */AV ECU
IF27	—	—
IF28	—	—
IF29	—	—
IF30	20A	BCM*
IF31	20A	Integrated BCM*/BCM*
IF32	7.5A	Power liftgate module *video receiver module *
IF33	20A	Integrated BCM*
IF34	7.5A	Gearshift lever module/Lane departure warning module *
IF35	7.5A	GWM/PEPS ECU*
IF36	15A	Integrated BCM*/BCM*

## 7. Technical data

No.	Rated value	Feature/part
IF37	30A	Integrated BCM*/BCM*/combination instrument
IF38	10A	Instrument panel switch group-right/instrument panel switch group-left/PEPS ECU*/EPB switch
IF39	20A	BCM*
IF40	20A	Integrated BCM*/BCM*
IF41	7.5A	Driver OBD DLC 1/front passenger OBD DLC 2
IF42	20A	Integrated BCM*/BCM*
IF43	Dark current switch	AV control unit/GWM/left front seat connector (HVSM) */HVAC control unit/touch control screen/Rain and light sensor *
IF44	30A	Power liftgate module *
IF45	30A	Right front door control module *
IF46	30A	Left front door control module *
IF47	—	—
IF48	—	—
IF49	20A	BCM*
IF50	10A	IG2 power supply
IF51	20A	Right front seat connector (seat adjusting switch) *
IF52	20A	Right front seat connector (seat adjusting switch) *
IF53	15A	Integrated BCM*/BCM*
IF54	20A	BCM*

No.	Rated value	Feature/part
IF55	—	—
IF56	20A	Panoramic sunroof sunshade *
IF57	—	—
IF58	—	—
IR01	—	ACC relay
IR02	—	Lock-up relay 1
IR03	—	Lock-up relay 2
IR04	—	IG1 relay
IR05	—	—
IR06	—	—
IR07	—	IG2 relay

## 7. Technical data

### Fuse in engine compartment PDU

The fuses may slightly vary from vehicle to vehicle. In this regard, the actual vehicle shall prevail.

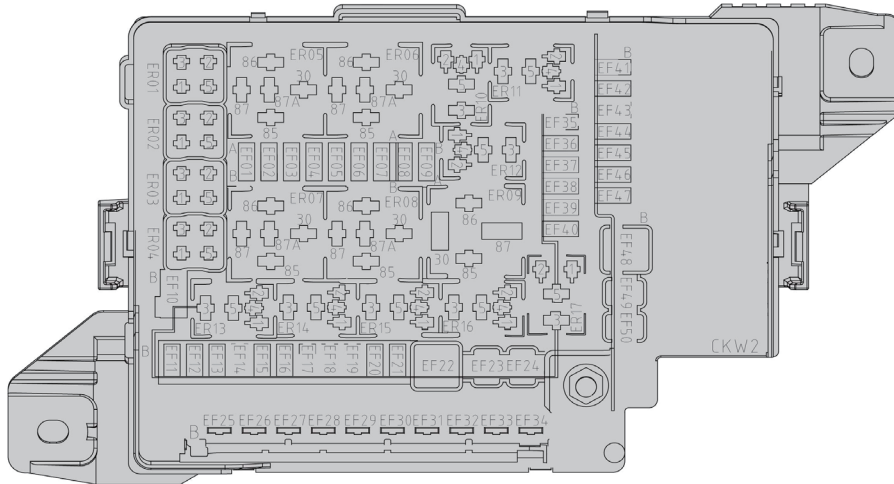

OMA58-0331

## 7. Technical data

No.	Rated value	Feature/part
EF01	—	—
EF02	15A	Left front combination lamp *
EF03	15A	Right front combination lamp *
EF04	7.5A	Engine control unit
EF05	—	—
EF06	—	—
EF07	—	—
EF08	—	—
EF09	—	—
EF10	7.5A	WDCT control unit
EF11	30A	WDCT control unit
EF12	15A	Horn relay (ER03)/horn
EF13	30A	WDCT control unit
EF14	7.5A	MRR module *
EF15	—	—
EF16	20A	Fuel pump
EF17	20A	Wiper speed relay (ER11)/ wiper relay (ER12)/ front wiper motor
EF18	7.5A	Brake switch/low beam relay (ER13)
EF19	7.5A	Engine control unit/main relay (ER17)
EF20	—	—
EF21	—	—

No.	Rated value	Feature/part
EF22	60A	Instrument panel PDU
EF23	40A	ESPI
EF24	30A	IG1 power supply
EF25	30A	Starter excitation coil/engine control unit
EF26	40A	ACC power supply
EF27	40A	To HVAC assembly (blower)
EF28	—	—
EF29	50A	GWM */T-BOX ECU*/AV control unit */ left front seat connector */HVAC control unit
EF30	—	—
EF31	—	—
EF32	60A	Instrument panel PDU
EF33	—	—
EF34	80A	EPS control unit
EF35	10A	Water pump relay (ER02)/fuel pump relay (ER14)/radiator fan control module
EF36	15A	Ignition coil 1 / ignition coil 2 / ignition coil 3 / ignition coil 4
EF37	15A	Engine control unit
EF38	10A	Compressor relay (ER04)/upstream oxygen sensor/downstream oxygen sensor/starter relay 1(ER15)/starter relay 2(ER16)

## 7. Technical data

No.	Rated value	Feature/part
EF39	10A	PCV heater relay (ER01)/PCV heater/canister vent valve/electronic intake air recirculation valve/canister solenoid valve/oil control valve (intake end)/oil pump solenoid valve/oil control valve (exhaust end)
EF40	—	—
EF41	30A	Left front combination lamp
EF42	10A	Right front combination lamp
EF43	30A	Electric water pump
EF44	7.5A	High beam relay (ER10)/left front combination lamp */right front combination lamp *
EF45	7.5A	A/C compressor
EF46	—	—
EF47	—	—
EF48	40A/60A	ESPI
EF49	30A	Electronic P gear actuator
EF50	—	—
ER01	—	PCV heater relay
ER02	—	Water pump relay
ER03	—	Horn relay
ER04	—	Compressor relay
ER05	—	Blower relay
ER06	—	—

No.	Rated value	Feature/part
ER07	—	—
ER08	—	—
ER09	—	—
ER10	—	High beam relay
ER11	—	Wiper speed relay
ER12	—	Wiper relay
ER13	—	Low beam relay
ER14	—	Fuel pump relay
ER15	—	Starter relay 1
ER16	—	Starter relay 2
ER17	—	Main relay

## 8. Accident handling

### 8.1 Driver's tools and spare tire

#### Driver's tools

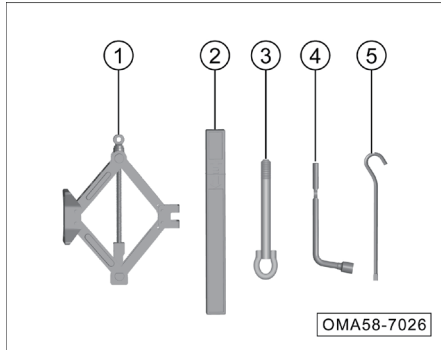

The following tool kit provided by the vehicle shall be placed in the trunk. After use, they shall be cleaned in time and put back to the original position.

- ① Jack
- ② Warning triangle
- ③ Towing hook
- ④ Wheel bolt removal wrench
- ⑤ Special wrench for jack

#### First-aid packet \*

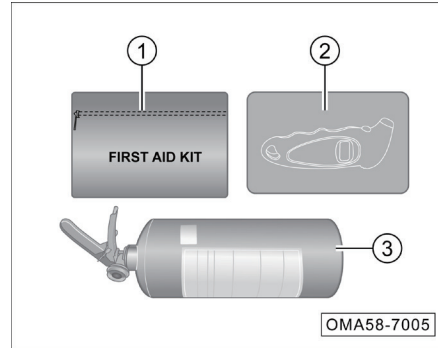

The first-aid packet contains:

- ① Medical kit: The medical kit contains emergency materials for trauma treatment such as hemostatic and bandaging (such as medical gauze kit, medical adhesive tape, medical breathable bandage, triangle bandage, iodophor swab, dressing tweezers, and safety scissors) needed for emergency treatment of trauma.
- ② Tire pressure gauge: Used to measure the tire pressure.
- ③ Portable dry powder extinguisher: Used for emergency extinguishing in case of fire.

#### Spare tire

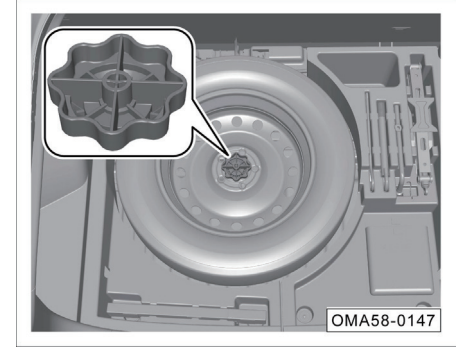

Take out the spare tire:

- Open the liftgate.
- Lift the trunk carpet.
- Unscrew the central handwheel of the spare tire counterclockwise to take out the spare tire.



### **i** NOTE

The spare tire has been inflated, and its tire pressure shall be checked regularly to ensure that it is at the specified maximum pressure, and multiple inspections shall be carried out within 1 year.

### **⚠** WARNING

- Use the spare tire in strict accordance with the use requirements to avoid danger.
- It is strictly forbidden to install and use more than one spare tire at the same time.
- Do not use spare tire that has been damaged or worn to the limit.
- The storage life of spare tire is 6 years, and it is forbidden to use it beyond the expiration date.
- The tire pressure shall be checked as soon as possible after the spare tire is installed to make it within the specified range.
- The maximum speed of the spare tire shall not exceed 80 km/h, and rapid acceleration and emergency braking shall be avoided.

## 8.2 Use of warning triangle

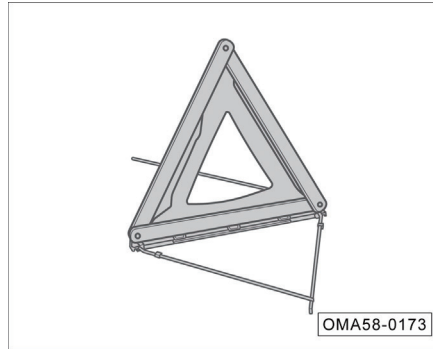

- Open the liftgate.
- Lift the trunk floor.
- Take out the warning triangle and use it.

### Placement distance

Ordinary highway		Expressway
Daytime	Night	
≥50 m	≥80 m	≥150 m

### **👁** CAUTION

The above data is for reference only. Please place the warning triangle at the actual distance specified by traffic regulations.

## 8. Accident handling

### 8.3 Use of reflective vest

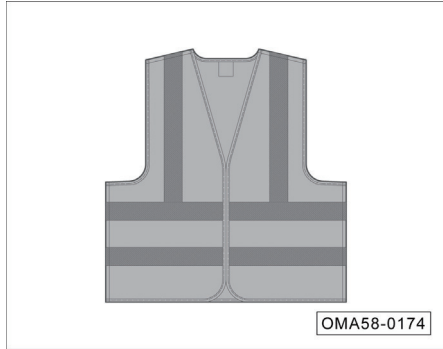

- If the vehicle needs to stop due to an accident or other faults, take out the reflective vest from the glove box and wear it neatly before getting off to check and deal with the vehicle faults.

#### **i** NOTE

- When handling a vehicle accident, it is important to wear a reflective vest as required to draw the attention of pedestrians or drivers of other vehicles, regardless of the lighting conditions.
- After using the reflective vest, please store it in the glove box properly. If necessary, clean it according to the indication on the collar mark to maintain the reflective performance.

### 8.4 Replacement of flat tire

#### Preparations

- Apply the parking brake.
- Set the gearshift lever to “P” gear.
- Switch the vehicle power to the “OFF” position and turn on the hazard warning lamp.
- Place a warning triangle in a suitable position behind the vehicle.
- Find a suitable object to wedge the wheel diagonally opposite to the wheel to be replaced to prevent the vehicle from moving.
- Take out the driver’s tools and the spare tire.

#### **⚠** WARNING

- **Relevant regulations must be strictly followed.**
- **All occupants must leave the vehicle and wait in a safe position.**

### Unscrewing the wheel bolts

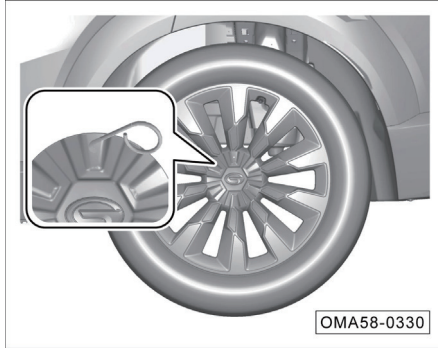

- For models equipped with wheel hub trim cover\*, remove the trim cover before removing the wheel. Use the hub trim cover removal tool\* to pry off the trim cover from the small hole.



Set the wheel bolt removal wrench on the wheel bolts and loosen the wheel bolts counterclockwise.

### CAUTION

Loosen the wheel bolts only one turn before lifting the vehicle. After lifting the vehicle, unscrew the wheel bolts completely and remove the flat tire.

### Lifting vehicle

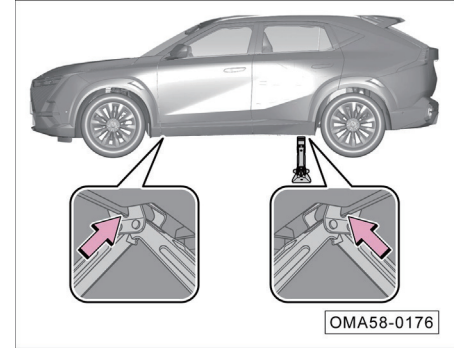

- Place the jack directly under the spine closest to the flat tire.
- Extend the jack high to ensure that the groove of the jack can engage with the spine.
- Check whether the jack is stable and tightly attached to the ground.

## 8. Accident handling

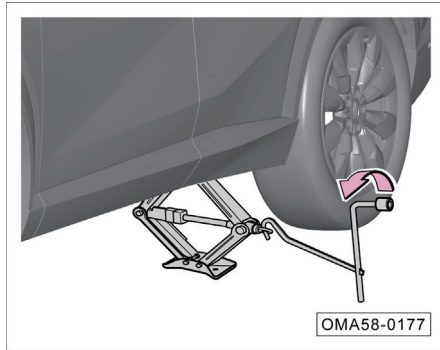

- Assemble the wheel bolt removal wrench, jack special wrench and jack.
- Extend the jack clockwise and lift the vehicle to make the tire leave the ground.

### ⚠ WARNING

Improper use of jack will cause serious injury.

- The jack must be used on a hard and flat ground, or a hard backing plate (no higher than 1 cm) can be placed under the jack as required.
- Strictly observe the precautions for jack operation.
- If there is a towing trailer, the trailer must be separated from the vehicle.
- Observe the status of the vehicle continuously during the lifting. If the vehicle body is noticeably tilted, stop the lifting, identify the problem, and then lift the vehicle after solving the problem.

### ⚠ WARNING

- The on-board jack can only be used to lift the vehicle, not other heavy objects or vehicles.
- When the jack is used, do not start the engine, otherwise an accident will occur.
- When lifting the vehicle with a jack, remember not to place any part of the body under the vehicle to avoid accidents.
- If it is really necessary to work under the vehicle, proper protective support must be placed under the vehicle.

### Remove flat tire

- Unscrew the loosened wheel bolts with a wheel bolt removal wrench when the vehicle is lifted.
- Remove the flat tire.

### Install spare tire

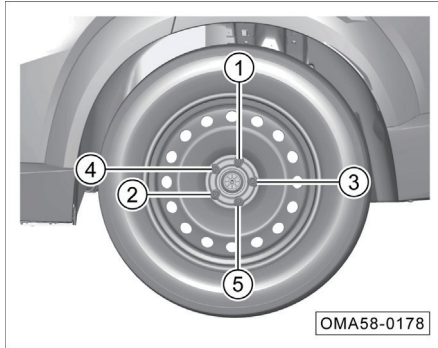

- Install the spare tire on the vehicle.
- Install all wheel bolts and pre-tighten them with wheel bolt removal wrench in the order of ①~ ⑤ in the figure.
- Make a verbal warning, after confirming that there is no one around the vehicle, reverse the jack wrench and lower the vehicle.
- Tighten all wheel bolts with the wheel bolt removal wrench.

- In order to avoid the noise of the vehicle during driving later on, please remember the locations of various tools, put them back in place after use and fix them.

### CAUTION

After installing the wheels, you should go to the GAC Motor authorized shop in time to check the tightening torque of the wheel bolts (the tightening torque of the wheel bolts is  $125 \pm 10 \text{ N}\cdot\text{m}$ ), otherwise the bolts may become loose when the vehicle is running, which is very likely to cause traffic accidents.

### WARNING

- The threads on the wheel bolts and wheel hubs must be kept clean, so that the bolts are easy to tighten, and there must be no grease or other attachments.
- When replacing a tire, if a bolt is rusted or difficult to tighten, it must be replaced and the threaded hole must be cleaned.
- When the spare tire is not in use, it must be reliably fixed at the spare tire mounting position.

## 8. Accident handling

### 8.5 Fuse

#### Instrument panel PDU

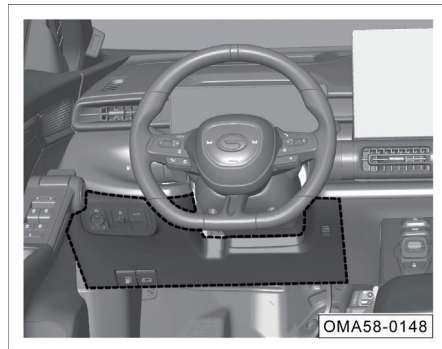

- Remove the left lower guard of the instrument panel (shaded part with dotted lines) to expose the fuse above the instrument panel PDU.

#### Engine compartment PDU

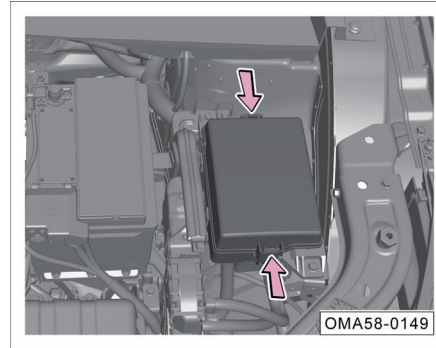

- Open the engine hood.
- Press the fixing clip in the direction of arrow to release the cover of the PDU.
- The fuse above the engine compartment PDU is exposed when the cover of the PDU is removed.



#### WARNING

Do not use high-pressure water gun to flush the engine compartment fuse box.

#### Replacing fuse

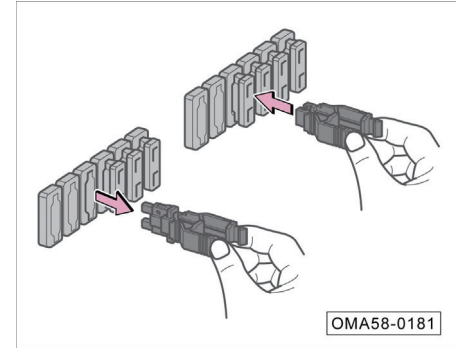

- Pull out or install the fuse using the fuse puller in the engine compartment PDU.

### Blown fuse

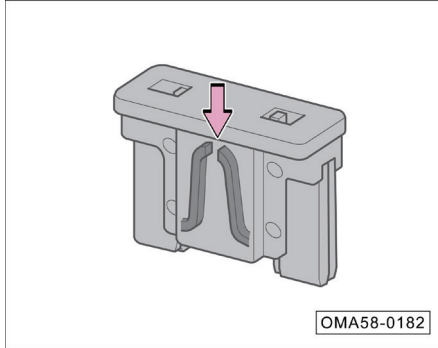

- If the fuse is blown (- arrow -), replace it with a new one with the same color and mark (it is recommended to replace it at the GAC Motor authorized shop).

#### NOTE

Some electric consumers may have multiple fuse, or multiple electric consumers may share a single fuse.

#### CAUTION

- Turn off all electrical equipment before replacing the fuse.
- If you need to replace the fuse, please consult the GAC Motor authorized shop.

#### WARNING

- **Fuse shall not be reused.**
- **Do not use fuses rated above the specified current value, otherwise it will damage other parts of the electrical system.**
- **Using unsuitable or patched fuse can cause short circuit or even fire.**
- **The color and logo of the replaced fuse must be exactly the same as that of the original fuse.**
- **Do not replace fuse with metal sheets, paper clips, etc.**
- **The PDU must be kept clean inside. Pay attention to protection against moisture.**

## 8. Accident handling

### 8.6 Emergency start

#### Jumper cable

If the engine cannot be started due to low battery level, the engine can be started by connecting to the battery of the other vehicle via jumper cable.

#### CAUTION

Before jumper cable operation, be sure to turn off all electrical equipment of the vehicle with depleted battery, such as headlamp, A/C, AV system, etc.

#### WARNING

- **The engine compartment is a high-risk area, and improper operation can easily lead to casualties.**
- **Be sure to carefully read and follow the safety warning instructions before starting the battery operation.**

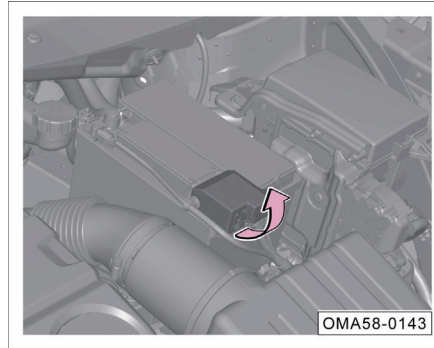

1. Open the engine hood and pull up the battery positive cover in the direction of the arrow.

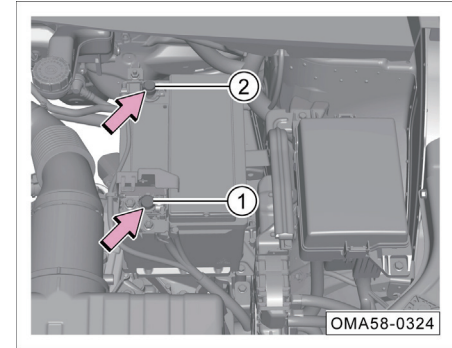

2. Connect the clip of the red positive jumper cable to the battery positive pole position ① of the vehicle, and connect the clip at the other end to the positive pole of the other vehicle battery; Connect the clip of the black negative jumper cable to the battery negative pole position ② of the vehicle, and connect the clip at the other end to the engine block of the other vehicle or the metal part firmly connected to the engine block.
3. Start the engine of the vehicle with the battery to supply, let it run at idle speed, and then start the engine of the vehicle with the battery to be supplied until the engine runs smoothly.
4. Remove the jumper cable in the reverse order after the engine runs smoothly.



### CAUTION

- When connecting the battery of two vehicles, the positive terminals must be connected first, and then the negative terminals.
- Properly arrange the jumper cable to avoid contact between the cable and the moving parts of the engine.

### WARNING

- **Ensure that the headlamps are off before removing the jumper cable.**
- **Turn on the blower and rear windshield heater of the vehicle with the depleted battery to reduce the voltage peak generated when the cable is removed.**
- **Remove the jumper cable in the reverse order when the engine is running.**

### WARNING

**Improper use of jumper cable may cause battery explosion and serious injury to personnel.**

- **The voltage of the power supply battery must be the same as that of the depleted battery, and the capacity of the two batteries must be the same as much as possible. Otherwise, it may cause an explosion.**
- **Do not expose the battery to open fire, and beware of explosion.**
- **Do not connect the negative cable directly to the negative terminal of the battery without power. There shall be no static electricity near the battery, otherwise, the combustible gas generated by the battery may be ignited by sparks, causing explosion.**
- **Do not connect the negative cable to the fuel system component or brake pipeline, and do not bend over to the battery during operation to avoid being burned by acid.**

### WARNING

**The jumper cable shall be correctly connected to the positive and negative terminals of the battery according to the above instructions, and shall not be connected to other positions of the battery. Otherwise, the fuse may be ablated or part of the vehicle may not work, and our company shall not assume any responsibility for this.**

## 8. Accident handling

### 8.7 Vehicle towing

If the vehicle needs to be towed, it shall be done by a GAC Motor authorized shop or a professional towing company.

Towing by a rollback tow truck is recommended. If the conditions can not be met, the wheel-lift truck may also be used for towing.

#### Towing by rollback tow truck

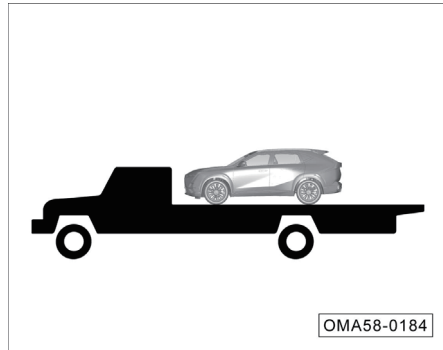

#### Towing by wheel-lift truck from the front

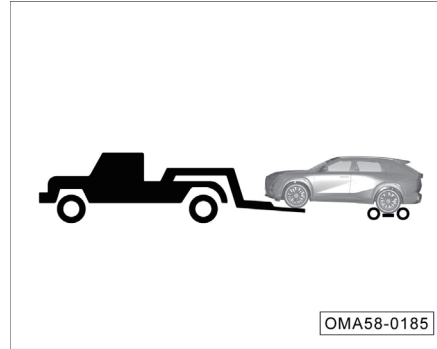

- Place a trolley under the rear wheels.

#### Towing by wheel-lift truck from the rear

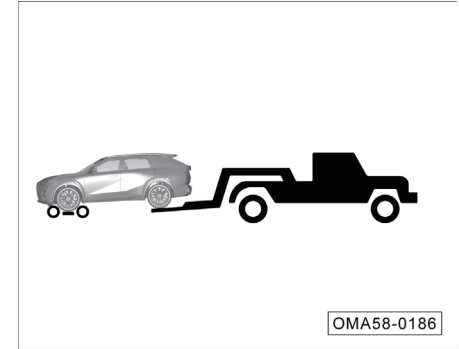

- Place a trolley under the front wheels.

### Emergency towing

If a towing truck cannot be found in an emergency, the towing cable or towing chain can be fastened in the emergency towing eye for temporary towing, but this method is only suitable for low-speed and short-distance towing on solid and flat roads.

#### WARNING

**Drive slowly during emergency towing and avoid violent operation. Excessive towing will damage the vehicle.**

### Installing a towing hook



- Pry off the towing hook cover in the arrowed position using a slotted screwdriver wrapped with a cloth.

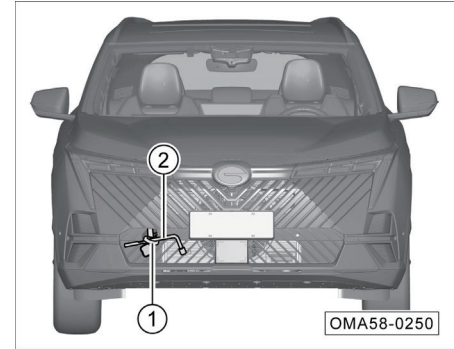

- Take out the towing hook ① and wheel bolt removal wrench ② from the driver's side tool box in the trunk.
- Screw the towing hook ① clockwise into the thread hole.
- Insert the wheel bolt removal wrench ② into the round opening of the towing hook, and turn the wheel bolt removal wrench clockwise to screw the towing hook firmly into the threaded hole.

## 8. Accident handling

---

### Precautions for towing

Before emergency towing, be sure to follow the following items:

- The towing and towed vehicles must turn on the hazard warning lamps and comply with local traffic regulations.
- The towing hook must be firmly tightened in the thread hole. Otherwise, the towing hook may slip out of the thread hole during towing.
- The towed vehicle must be shifted into "N" gear.
- For the towed vehicle, set the vehicle power switch to the "ON" position and turn the steering wheel back and forth to confirm that the steering wheel can be turned.

During the emergency towing process, be sure to follow the following items:

- Start the engine and drive at a slow speed till the towing rope is tight and then accelerate the vehicle slowly.
- Be sure to drive steadily, and do not accelerate, decelerate, or turn the vehicle sharply.
- During the towing, the towed vehicle shall be braked earlier than normal, but the brake pedal shall be slightly depressed.
- During towing, the towing rope must always be in a tight state.

### 8.8 Vehicle out of trap

If the vehicle is trapped on a soft road such as sand, mud or snow, follow the following steps to get the vehicle out of the trap:

1. Observe the front and rear areas of the vehicle to ensure that there are no obstacles.
2. Turn the steering wheel left and right to grind out an area around the front wheels without mud, snow or sand trapped around the tires.
3. Place wooden blocks, stones or other materials to help increase tire friction.
4. Start the vehicle and accelerate slowly to get the vehicle out of the trap.
5. If the vehicle still cannot get out of the trap after attempts for several times, it is required to have a tow truck for rescue.

#### **i** NOTE

In the process of acceleration, the vehicle can be driven out of the trap by means of pushing forward and backward with human assistance.

**This manual describes the configuration, function, performance parameters, product schematic diagram and other related information of the whole series of GAC Motor. The contents are valid at the time of printing. However, the actual configuration and function of the vehicle shall be subject to the delivered vehicle. If there is any difference between the product schematic diagram and the delivered vehicle, the actual product shall prevail.**

**GAC Motor Co., Ltd. reserves the right to change, supplement or terminate the contents and technical specifications in this manual without prior notice.**

**GAC Motor Co., Ltd. owns the copyright of this manual. Without the written consent of the GAC Motor Co., Ltd., the contents of this manual shall not be photocopied or extracted.**

**GAC Motor Co., Ltd.**